

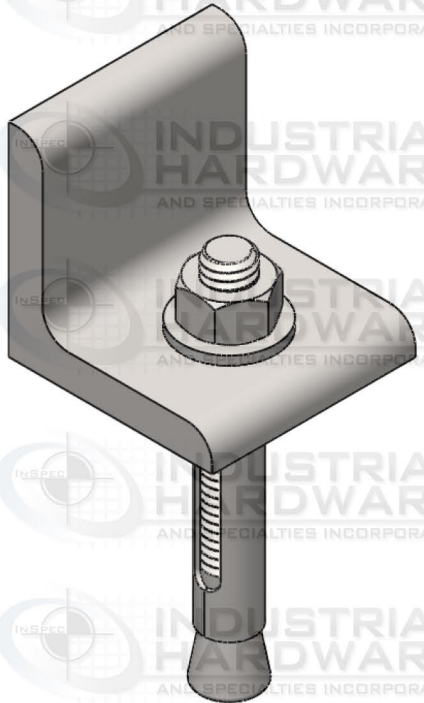

ZONE		REV.	REVISIONS	DATE	APPROVED
			DESCRIPTION		

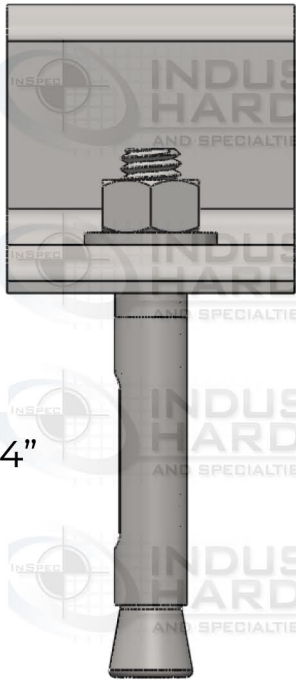
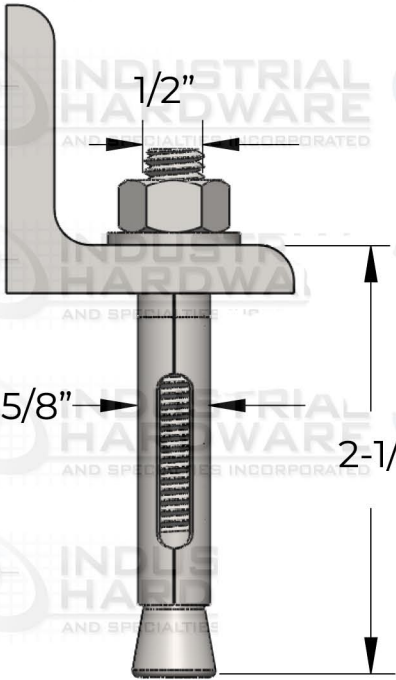
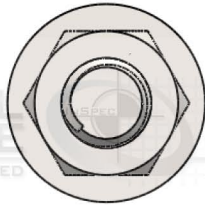
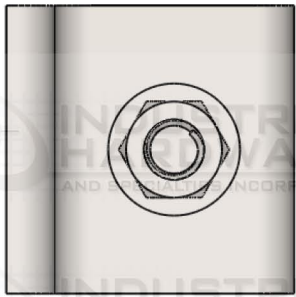

PROPRIETARY AND CONFIDENTIAL

THIS DRAWING AND ITS CONTENT IS THE SOLE PROPERTY OF INDUSTRIAL HARDWARE & SPECIALTIES, INCORPORATED.

ANY REPRODUCTION IN PART OR AS A WHOLE WITHOUT THE WRITTEN PERMISSION OF INDUSTRIAL HARDWARE & SPECIALTIES, INC. IS STRICTLY PROHIBITED. INSPEC AND TOSPEC INDICIA ARE REGISTERED AND PROTECTED TRADEMARKS WITH THE UNITED STATES PATENT & TRADEMARK OFFICE. MODIFICATION, USE OR REMOVAL WITHOUT WRITTEN AUTHORIZATION WILL BE DEEMED AN INTENTIONAL VIOLATION OF COPYRIGHT PROTECTIONS.

		DIMENSIONS ARE IN INCHES TOLERANCES: FRACTIONAL $\pm 1/64"$ ANGULAR: MACH $\pm 1^\circ$ BEND $\pm 1^\circ$ TWO PLACE DECIMAL $\pm .01"$ THREE PLACE DECIMAL $\pm .005"$ CONCENTRICITY T.I.R. = $.005"$		NAME	DATE	 INDUSTRIAL HARDWARE AND SPECIALTIES INCORPORATED 17-B Kentucky Avenue Paterson, New Jersey 07503 T: 973-684-4010 F: 973-684-3095 e-mail: sales@industrialhardware.com www.industrialhardware.com SIZE DWG. NO. A 20A-1F15 SCALE: 1:2 WEIGHT: SHEET 1 OF 1
		MATERIAL Steel	DRAWN			
		FINISH Zinc CR+3 (RoHS)	CHECKED			
			ENG APPR.			
NEXT ASSY	USED ON		MFG APPR.		COMMENTS:	
APPLICATION		DO NOT SCALE DRAWING	Q.A.			