

Key-Locking Non-Locking

REVISIONS		DATE	APPROVED
ZONE	REV.	DESCRIPTION	

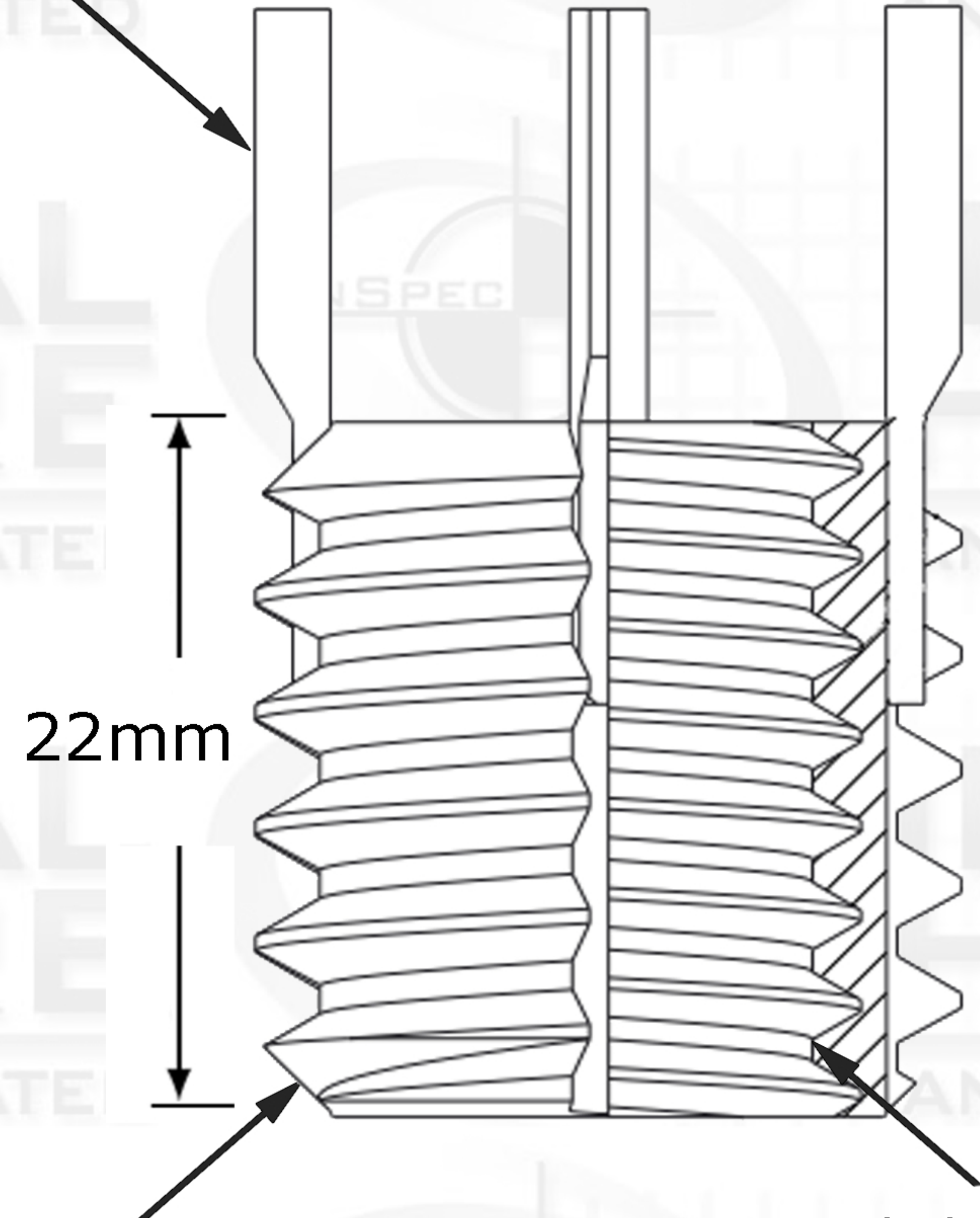

Key



22mm

External Thread Pitch
M22 x 1.5

Internal Thread Pitch
M16 x 1.5

Suggested Drill Bit Size



0.8125 (13/16)

PROPRIETARY AND CONFIDENTIAL

THIS DRAWING AND IT'S CONTENT IS THE SOLE PROPERTY OF INDUSTRIAL HARDWARE & SPECIALTIES,INC.. ANY REPRODUCTION IN PART OR AS A WHOLE WITHOUT THE WRITTEN PERMISSION OF INDUSTRIAL HARDWARE & SPECIALTIES,INC. IS STRICTLY PROHIBITED.

		Internal		NAME	DATE
		TH. STANDARD: ISO Metric		DRAWN	
		ACRONYM: ISO		CHECKED	
		ROTATION: Right-Hand		ENG APPR.	
		External		MFG APPR.	
		TH. STANDARD: ISO Metric		Q.A.	
		ACRONYM: ISO			
		ROTATION: Right-Hand			
		MATERIAL FINISH			
		Stainless Steel Type 303	COMMENTS:		
NEXT ASSY	USED ON	PART NUMBER			
		35L8C-687W-C16J			
APPLICATION		DO NOT SCALE DRAWING			



**17-B KENTUCKY AVENUE
PATERSON, NEW JERSEY 07503
TEL: 973-684-4010 FAX: 973-684-3095
email: TechSupport@industrialhardware.com
www.industrialhardware.com**

SIZE	DWG. NO.	REV.
A		
SCALE:1:8	WEIGHT:	SHEET 1 OF 1