

9630

Heavy Duty Pocket Door Kit

Notes:

- For size options review the Size Options chart
- For kit contents see Related Files
- Compares to:
 - Stanley 40-3925/PDF150
 - National 882
 - Johnson 153068PF

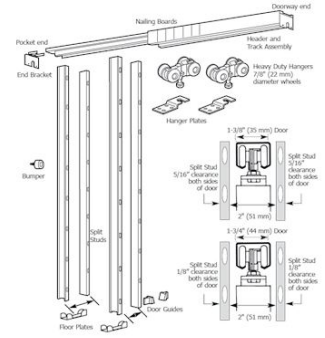

PRODUCT SPECIFICATIONS

PRODUCT SPECIFICATIONS:

- For doors 1-3/8" - 1-3/4" (35mm - 44 mm) thick, up to 3'0" (914 mm) wide and 7'0" (2184 mm) high
- For door weighing up to 150 lbs (68 kg)
- 9601 aluminum jump proof box track with quick release rollers
- Pre-assembled header assembly goes up quickly
- Easy door installation and removal for painting and repair
- 2 pair of wood split studs with wood inserts
 - size 3/4" (19 mm) x 1-5/8" (26 mm) length relative to height
 - steel encased for rigidity and to prevent fastener penetration into the pocket
- Track header unit attaches to rough framing at both ends
- Split studs can be nailed or screwed to track header
- Conform to ANSI A156 14/ Type: D8671, D8701

INSTALLATION:

- For Bi-Parting Doors use Hager Double Pocket Door Kit 9639 (sold separately)
- Joins 2 pocket door frames to make one large doorway. Rough opening width changes to 4 times one door width.

PRODUCT SIZE OPTIONS

MODEL #	MAX. DOOR WEIGHT	DOOR THICKNESS	DOOR WIDTH	DOOR HEIGHT	HANGER BEARINGS
9630	150 lbs (68 kg)	1-3/8" - 1-3/4" (35 mm - 44 mm)	3'0" (914 mm)	7'0" (2134 mm)	Steel Ball