

Trim & Auxiliary



At Hager Companies, we know all about the importance of adding the finishing touches to your building projects. That's why we're proud to offer more than 200 different trim & auxiliary door hardware products in a variety of designs, sizes, and finishes that not only look great, but also provide long-lasting wear in any application. Whatever you need, from pulls to push plates, protection plates to door edgings, wall and floor stops to flush bolts, coordinators, signage, and much more - Hager trim & auxiliary products give you great looks and proven durability.

Table of Contents

General Information	2
Pulls	5
Flush Cap Pulls	22
Pull Plates.....	26
Push Plates	28
Push Bars	32
Push & Pull Bar Sets.....	35
Door Edgings & Corner Guards	40
Door Protection Plates	42
Wall Stops & Holders.....	43
Roller Stops	48
Floor Stops & Holders.....	49
Kick Down Door Stops.....	56
Surface Bolts	57
Flush Bolts & Coordinating Devices	58
Latches & Protection Plates.....	65
Coat Hooks	69
Pulls - Closet/Pocket/Sliding Door.....	71
Filler Plates.....	74
Signage	76
Miscellaneous	81
Residential	85



GENERAL INFORMATION

MANUFACTURING OPTIONS

Hager Companies can deliver custom door pulls made to your specifications, or choose from our collection of pull designs. Hager's comprehensive selection of door pull hardware includes standard push/pull bars or multiple push bar combinations with center-to-centers made to order.

PUSH/PULL PLATE DETAILS

Standard Grip Positions

Pulls are centered vertically or lowered when necessary to meet minimum top spacing requirement. Be certain the pull selected will fit on specified plate under these conditions.

Special Pull Positions

Where pairs of doors are involved and active leaf pull plate is lettered or has a cutout, order pull plate for inactive leaf Grip To Align (WOC). This will ensure horizontal alignment of pull on both plates. Always furnish complete details when ordering non-standard pull positions.

PULL PLATES UP TO 4" WIDE

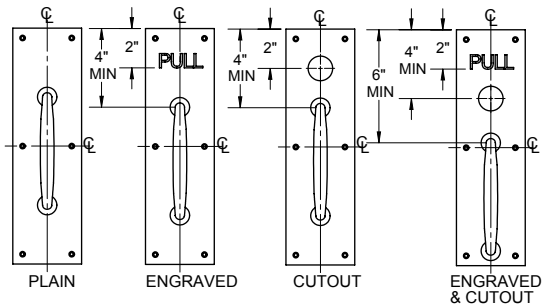

PULL PLATES OVER 4" WIDE (HANDING REQUIRED WITH CUTOUTS)

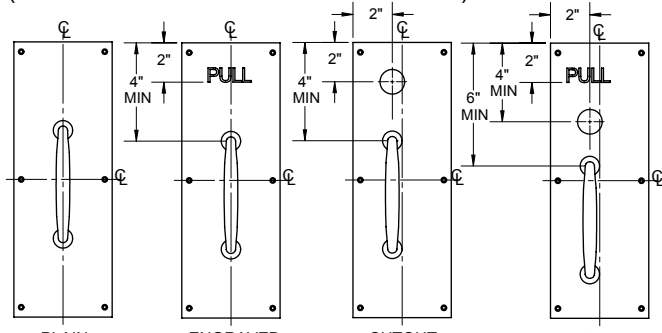

Cut Outs

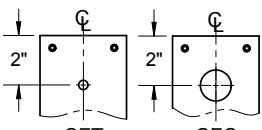

Standard cutout sizes: Cut for Cylinder (CFC) – 1 1/4" (32 mm) diameter; Cut for Thumbturn (CFT) – 3/8" (10 mm) diameter.

All plates may be ordered with cutout option by adding the appropriate suffix (i.e., 30S-CFC).

Standard cutouts are positioned 2" (51 mm) from top of plate where this option has been ordered. Cutouts are centered

on plates up to 4" (102 mm) wide or 2" (51 mm) from edge of plates over 4" (102 mm) wide. The latter are handed with cutouts. Furnish hand of door when ordering. Provide complete details for all non-standard cutouts.

Flush Back Mounting

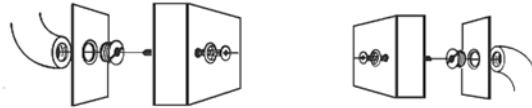

Pull plates using #3, 4, or 10 pull types can be furnished with a flush back (no projections). Specify code FB, (i.e., 33E-FB). Note: Use thru bolts supplied with mountings for best security.

Back To Back Mounting

Many pulls may be ordered back to back (BTB) and availability will be noted on each particular product page (refer to product page). Specify the correct part number and center-to-center unless already specified.

Handicap Option

Pulls that must meet the 2-1/2" (64 mm) clearance for ADA requirements are available. Must specify part number with prefix "H" (i.e., H2E). Please refer to each individual part number for availability.

Engraving

Typical engraved lettering is in Helvetica style and colored black. On push or pull plates, standard position is horizontal on a line 2" (51 mm) from top of plate.

PUSH PULL

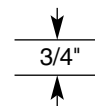



GENERAL INFORMATION

Fasteners

Illustrated below are various types of fasteners that can be furnished by Hager Companies. Please specify type of fastening desired. All types of fastening cannot be used with all items of hardware. If specified method is not possible, we reserve the right to furnish whatever type we feel is best suited for the installation. When used with tempered glass doors, specify thickness of glass and hole diameter. Fasteners are standard for 1-3/4" doors. Other door thicknesses are optional.



Sex bolt and machine screws

(various sizes)



Lead anchor

(used with floor stops in masonry applications)



Plastic anchor and full threaded screw

(used in drywall or masonry applications)



Lag screw and shield

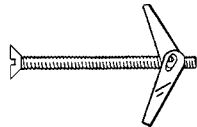

Toggle bolt

(ideal for drywall applications)

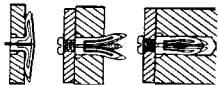

Plastic toggle anchor

(used with wall stops in drywall applications)



Thru-bolt and finish washer

(flat or oval head; size as required)



Spanner head machine screws

(various sizes furnished at extra charge)



Security torx head machine screws

(various sizes furnished at extra charge)

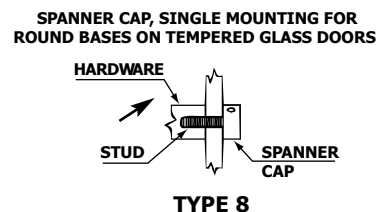
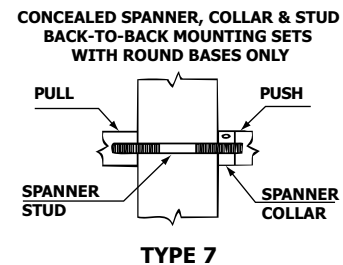
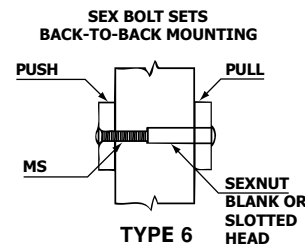
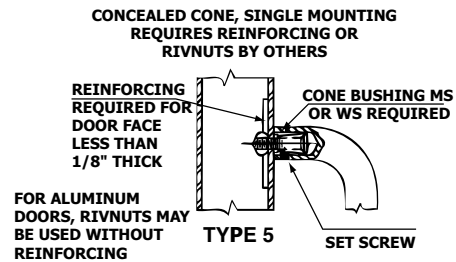
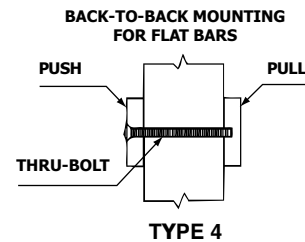
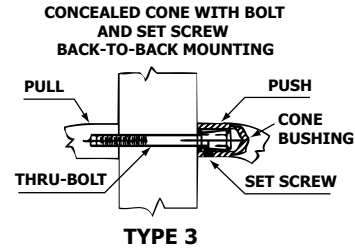
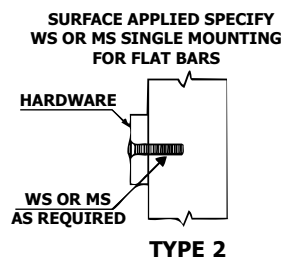
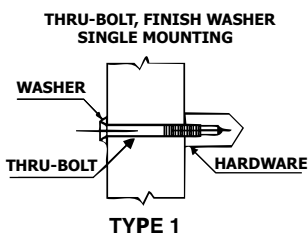

GENERAL INFORMATION

METAL FINISH SYMBOLS

US & Hager	Description	Base Material	BHMA Symbol
2C	Zinc Plated Steel	Steel	603
3	Bright Brass	Brass	605
4	Satin Brass	Brass	606
5	Satin Brass, Oxidized	Brass/Bronze	609
9	Bright Bronze	Brass/Bronze	611
10	Satin Bronze	Brass/Bronze	612
10B	Antique Bronze, Oiled	Brass/Bronze	613
10R	Matte Lacquer Antique Bronze	Brass/Bronze	-
15	Satin Nickel	Brass/Bronze	619
15A	Satin Nickel Oxidized	Brass/Bronze	620
19	Flat Black Coated	Brass	622
26	Bright Chromium Plated	Brass/Bronze	625
26D	Satin Chromium Plated	Brass/Bronze	626
28	Satin Anodized Aluminum	Aluminum	628
32	Stainless Steel Metal, Bright	300 Series	629
32D	Stainless Steel Metal, Satin	300 Series	630
L2	Duro	-	-
PC	Clear Plastic	-	-
PK	Plastic Laminate - Black	-	-
CO	Plastic Laminate - Chocolate	-	-
PG	Plastic Laminate - Grey	-	-
S1	Sprayed Aluminum	Cast Iron	-
S2	Sprayed Brass	Cast Iron	-
S3	Sprayed Bronze	Cast Iron	-

Note: For any finish not listed in this catalog, or explained above, availability on request.

ANTIMICROBIAL PROTECTION

Hager Companies' full line of US32D stainless steel door pulls, push bars, push plates, and pull plates are available with AgION antimicrobial protection.

Hager uses a powder coat process to apply the antimicrobial treated coating to guarantee durability and protection. Antimicrobial resistance on products is affected by moisture in the air. Silver ions interact with humidity and are released creating a cleaner surface. The suppression of bacteria, mold and fungi is as easy as adding antimicrobial treated coating to your Hager products.

Antimicrobial Vital Stats

- US32D stainless steel
- EPA registered
- NSF approved
- FDA listed for food contact
- Designate your product with: MV3 for Trim & Auxiliary





PULLS



1

Modified Half Round Wrought Door Pull

- Certification: Meets ANSI A156.6 for J401 Pulls
 Base: 1/2" x 1" (13 mm x 25 mm)
 Projection: 2" (51 mm)
 Clearance: 1-1/2" (38 mm)
 Door Thickness: 1-3/4" (45 mm) - Standard
 Materials: Aluminum, brass, bronze, stainless steel
 Finishes: US3, US4, US10, US10B, US26, US26D, US28, US32, US32D
 Fasteners: Two (2) 1/4-20 x 2-1/4" FPHMS with finish washers
 Handicap:
 - 2-1/2" (64 mm) clearance available on special orders
 - Add prefix "H" to number (i.e., H1E)
 Options:
 - May be combined with a plate to make a pull plate
 - Other centers on special order
 Notes:
 - For sizes or finishes not listed in this catalog, contact Hager Customer Service for availability
 - Not suitable for back to back mounting

CTC Length	1E	1G	1J	1L
Inches	6	8	10	12
Millimeters	152	203	254	305



2

Rectangular Wrought Door Pull

- Certification: Meets ANSI A156.6 for J401 Pulls
 Base: 3/8" x 1-1/4" (10 mm x 32 mm)
 Projection: 2" (51 mm)
 Clearance: 1-5/8" (41 mm)
 Door Thickness: 1-3/4" (45 mm) - Standard
 Materials: Aluminum, brass, bronze, stainless steel
 Finishes: US3, US4, US10, US10B, US26, US26D, US28, US32, US32D
 Fasteners: Two (2) 1/4-20 x 2-1/4" FPHMS with finish washers
 Handicap:
 - 2-1/2" (64 mm) clearance available on special orders
 - Add prefix "H" to number (i.e., H2E)
 Options:
 - May be combined with a plate to make a pull plate
 - Other centers on special order
 Notes:
 - For sizes or finishes not listed in this catalog, contact Hager Customer Service for availability
 - Not suitable for back to back mounting

CTC Length	2E	2G	2J	2L
Inches	6	8	10	12
Millimeters	152	203	254	305



3

Round Wrought Door Pull

- Certification: Meets ANSI A156.6 for J401 Pulls
 Base Diameter: 3/4" (19 mm)
 Projection: 2-1/4" (57 mm)
 Clearance: 1-1/2" (38 mm)
 Door Thickness: 1-3/4" (45 mm) - Standard
 Materials: Aluminum, brass, bronze, stainless steel
 Finishes: US3, US4, US10, US10B, US26, US26D, US28, US32, US32D
 Fasteners: Two (2) 1/4-20 x 2-1/4" FPHMS with finish washers
 Handicap:
 - 2-1/2" (64 mm) clearance available on special orders
 - Add prefix "H" to number (i.e., H3E)
 Notes:
 - For sizes or finishes not listed in this catalog, contact Hager Customer Service for availability
 - May be combined with a plate to make a pull plate
 - Other centers on special order
 - If ordered with tempered glass, specify glass thickness and hole size
 - Back to back - see model 13

CTC Length	3E	3G	3J	3L
Inches	6	8	10	12
Millimeters	152	203	254	305

PULLS



4 Round Wrought Door Pull

Certification: Meets ANSI A156.6 for J401 Pulls
 Base Diameter: 1" (25 mm)
 Projection: 2-3/4" (70 mm)
 Clearance: 1-3/4" (45 mm)
 Door Thickness: 1-3/4" (45 mm) - Standard
 Materials: Aluminum, brass, bronze, stainless steel
 Finishes: US3, US4, US10, US10B, US26, US26D, US28, US32, US32D
 Fasteners: Two (2) 1/4-20 x 2-1/4" FPHMS with finish washers
 Handicap:

Notes:

- 2-1/2" (64 mm) clearance available on special orders
- Add prefix "H" to number (i.e., H4E)
- For sizes or finishes not listed in this catalog, contact Hager Customer Service for availability
- May be combined with a plate to make a pull plate
- Other centers on special order
- If ordered with tempered glass, specify glass thickness and hole size
- Back to back - see model 13

CTC Length	4G	4H	4J	4L
Inches	8	9	10	12
Millimeters	203	229	254	305



P4E Security Pull

Certification: Meets ANSI A156.6 for J401 Pulls
 Base: 1" (25 mm) diameter
 Projection: 2-1/4" (57 mm)
 Clearance: 1-1/4" (32 mm)
 CTC Length: 6" (152 mm)
 Material: Stainless steel
 Finish: US32D
 Fasteners: Two (2) 3/8-16 x 1-1/4" "NYLOC" hex head cap screws
 Notes:

- For metal doors
- Requires reinforcing plate with an access plate and Torx screws for door edge

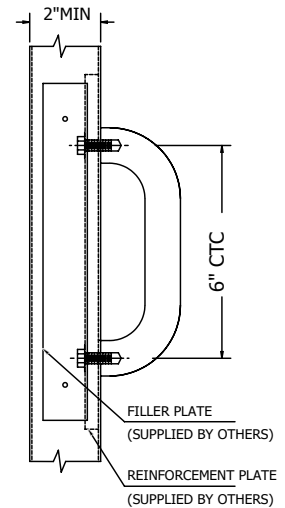

T4E Security Pull

Certification: Meets ANSI A156.6 for J401 Pulls
 Base: 1" (25 mm) diameter
 Projection: 2-1/4" (57 mm)
 Clearance: 1-1/4" (32 mm)
 Door Thickness: 1-3/4" (45 mm) - Standard
 CTC Length: 6" (152 mm)
 Material: Stainless steel
 Finish: US32D
 Fasteners: Two (2) 1/4-20 x 2-1/4" FTXMS with finish washers



PULLS



5D

Round Wrought Door Pull

Certification: Meets ANSI A156.6 for J401 Pulls

Base Diameter: 5/8" (16 mm)

Projection: 2-1/8" (54 mm)

Clearance: 1-1/2" (38 mm)

CTC Length: 5-1/2" (140 mm)

Door Thickness: 1-3/4" (45 mm) - Standard

Materials: Aluminum, brass, bronze, stainless steel

Finishes: US3, US4, US10, US10B, US26, US26D, US28, US32, US32D

Fasteners: Two (2) 1/4-20 x 2-1/4" FPHMS with finish washers

Handicap: • 2-1/2" (64 mm) clearance available on special orders

• Add prefix "H" to number (i.e., H5D)

Notes: • For sizes or finishes not listed in this catalog, contact Hager Customer Service for availability

• May be combined with a plate to make a pull plate

• If ordered with tempered glass, specify glass thickness and hole size

• Not suitable for back to back mounting



5N

Cast Pull

Certification: Meets ANSI A156.6 for J401 Pulls

O/A Height: 6-1/8" (156 mm)

Base: 5/8" x 1-3/16" (16 mm x 30 mm)

Projection: 2" (51 mm)

Clearance: 1-1/2" (38 mm)

CTC Length: 5-1/2" (140 mm)

Door Thickness: 1-3/4" (45 mm) - Standard

Materials: Aluminum, brass, bronze, stainless steel

Finishes: US3, US4, US10, US10B, US26, US26D, US28, US32D

Fasteners: Two (2) 1/4-20 x 2-1/4" FPHMS with finish washers

Options: May be combined with a plate to make a pull plate

Notes:

Not suitable for back to back mounting



6N

Cast Pull

Certification: Meets ANSI A156.6 for J401 Pulls

O/A Height: 6-1/2" (165 mm)

Base Diameter: 1" (25 mm)

Projection: 1-7/8" (48 mm)

Clearance: 1-3/8" (35 mm)

CTC Length: 5-1/2" (140 mm)

Door Thickness: 1-3/4" (45 mm) - Standard

Materials: Aluminum, brass, bronze, stainless steel

Finishes: US3, US4, US10, US10B, US26, US26D, US28, US32D

Fasteners: Two (2) 1/4-20 x 2-1/4" FPHMS with finish washers

Options: May be combined with a plate to make a pull plate

Notes:

Not suitable for back to back mounting



PULLS



7N

Cast Pull

Certification:	Meets ANSI A156.6 for J401 Pulls
O/A Height:	7-1/2" (190 mm)
Base Diameter:	2" (51 mm)
Projection:	1-7/8" (48 mm)
Clearance:	1-3/8" (35 mm)
CTC Length:	5-1/2" (140 mm)
Door Thickness:	1-3/4" (45 mm) - Standard
Materials:	Aluminum, brass, bronze
Finishes:	US3, US4, US10, US10B, US26, US26D, US28
Fasteners:	Two (2) 1/4-20 x 2-1/4" FPHMS with finish washers
Options:	May be combined with a plate to make a pull plate
Notes:	Not suitable for back to back mounting



8N

Cast Pull

Certification:	Meets ANSI A156.6 for J401 Pulls
O/A Height:	7-1/2" (190 mm)
Base Diameter:	2" (51 mm)
Projection:	1-7/8" (48 mm)
Clearance:	1-3/8" (35 mm)
CTC Length:	5-1/2" (140 mm)
Materials:	Aluminum, brass, bronze
Finishes:	US3, US4, US10, US10B, US26, US26D, US28
Fasteners:	Six (6) #8 x 1" OPHWS
Notes:	Not suitable for back to back mounting



P8N

Cast Pull

Certification:	Meets ANSI A156.6 for J401 Pulls
O/A Height:	8 - 3/4" (222 mm)
Base:	1-1/2" x 1-5/8" (38 mm x 41 mm)
Projection:	2-1/4" (57 mm)
Clearance:	1-9/16" (40 mm)
CTC Length:	7-3/4" (197 mm)
Materials:	Brass
Finishes:	US4, US26D
Fasteners:	Two (2) 3/8-16 x 3/4" FPHMS
Options:	Security Torx screws available
Notes:	Not suitable for back to back mounting





PULLS



9

Oval Wrought Door Pull

- Certification: Meets ANSI A156.6 for J401 Pulls
 Base: 1/2" x 3/4" (13 mm x 19 mm)
 Projection: 2" (51 mm)
 Clearance: 1-1/2" (38 mm)
 Door Thickness: 1-3/4" (45 mm) - Standard
 Materials: Brass, bronze, stainless steel
 Finishes: US3, US4, US10, US10B, US26, US26D, US32, US32D
 Fasteners: Two (2) 1/4-20 x 2-1/4" FPHMS with finish washers
 Handicap:
 - 2-1/2" (64 mm) clearance available on special orders
 - Add prefix "H" to number (i.e., H9E)
 Options:
 - May be combined with a plate to make a pull plate
 - Other centers on special order
 Notes:
 - For sizes or finishes not listed in this catalog, contact Hager Customer Service for availability
 - Not suitable for back to back mounting

CTC Length	9E	9G	9J	9L
Inches	6	8	10	12
Millimeters	152	203	254	305



10

Round Pull

- Certification: Meets ANSI A156.6 for J401 Pulls
 Base Diameter: 1-1/4" (32 mm)
 Projection: 3" (76 mm)
 Clearance: 1-3/4" (45 mm)
 Door Thickness: 1-3/4" (45 mm) - Standard
 Materials: Aluminum, brass, bronze, stainless steel
 Finishes: US3, US4, US10, US10B, US26, US26D, US28, US32, US32D
 Fasteners: Two (2) 5/16-18 FPHMS with finish washers
 Handicap:
 - 2-1/2" (64 mm) clearance available on special orders
 - Add prefix "H" to number (i.e., H10L)
 Options:
 - May be combined with a plate to make a pull plate
 - Other centers on special order
 - If ordered with tempered glass, specify glass thickness and hole size
 Notes:
 - For sizes or finishes not listed in this catalog, contact Hager Customer Service for availability
 - Back to back - see model 20

CTC Length	10L	10Q
Inches	12	18
Millimeters	305	457



11

Round Offset Pull

- Certification: Meets ANSI A156.6 for J402 Pulls
 Base Diameter: 3/4" (19 mm)
 Projection: 2-1/2" (64 mm)
 Offset: 2-1/2" (64 mm); 90° Standard
 Clearance: 1-3/4" (45 mm)
 Door Thickness: 1-3/4" (45 mm) - Standard
 Materials: Aluminum, brass, bronze, stainless steel
 Finishes: US3, US4, US10, US10B, US26, US26D, US28, US32, US32D
 Fasteners: Two (2) 5/16-18 x 2-1/4" FPHMS with finish washers
 Handicap:
 - 2-1/2" (64 mm) clearance available on special orders
 - Add prefix "H" to number (i.e., H11E)
 Options:
 - For 45° offset, add prefix "X" to number (i.e., X11E)
 - Other centers available on special orders
 - If ordered with tempered glass, specify glass thickness and hole size
 Notes:
 - For sizes or finishes not listed in this catalog, contact Hager Customer Service for availability
 - Back to back - see model 21

CTC Length	11E	11G	11J	11L
Inches	6	8	10	12
Millimeters	152	203	254	305



PULLS



**12
Round Offset Pull**

Certification: Meets ANSI A156.6 for J402 Pulls
 Base Diameter: 1" (25 mm)
 Projection: 2-3/4" (70 mm)
 Offset: 3" (76 mm); 90° Standard
 Clearance: 1-3/4" (45 mm)
 Door Thickness: 1-3/4" (45 mm) - Standard
 Materials: Aluminum, brass, bronze, stainless steel
 Finishes: US3, US4, US10, US10B, US26, US26D, US28, US32, US32D
 Fasteners: Two (2) 5/16-18 x 2-1/4" FPHMS with finish washers
 Handicap:

- 2-1/2" (64 mm) clearance available on special orders
- Add prefix "H" to number (i.e., H12G)
- For 45° offset, add prefix "X" to number (i.e., X12G)
- Other centers available on special orders
- If ordered with tempered glass, specify glass thickness and hole size

 Options:

- For sizes or finishes not listed in this catalog, contact Hager Customer Service for availability

 Notes:

- For sizes or finishes not listed in this catalog, contact Hager Customer Service for availability

CTC Length	12G	12J	12L
Inches	8	10	12
Millimeters	203	254	305



**13
Round Wrought Door Push/Pull Set**

Certification: Meets ANSI A156.6 for J401 Pulls
 Base Diameter: 3/4" (19 mm)
 Projection: 2-1/4" (57 mm)
 Clearance: 1-1/2" (38 mm)
 Door Thickness: 1-3/4" (45 mm) - 2-1/8" (54 mm) Standard
 Materials: Aluminum, brass, bronze, stainless steel
 Finishes: US3, US4, US10, US10B, US26, US26D, US28, US32, US32D
 Notes:

- Type 7 mounting - Standard
- Consists of two (2) pulls back to back
- For sizes or finishes not listed in this catalog, contact Hager Customer Service for availability
- Supplied with two (2) 1/4" dia. threaded studs, spanner collar, and spanner wrench

CTC Length	13E	13G	13J	13L
Inches	6	8	10	12
Millimeters	152	203	254	305



**14
Round Wrought Door Push/Pull Set**

Certification: Meets ANSI A156.6 for J401 Pulls
 Base Diameter: 1" (25 mm)
 Projection: 2-3/4" (70 mm)
 Clearance: 1-3/4" (45 mm)
 Door Thickness: 1-3/4" (45 mm) - 2-1/8" (54 mm) Standard
 Materials: Aluminum, brass, bronze, stainless steel
 Finishes: US3, US4, US10, US10B, US26, US26D, US28, US32, US32D
 Notes:

- Type 7 mounting - Standard
- Consists of two (2) pulls back to back
- For sizes or finishes not listed in this catalog, contact Hager Customer Service for availability
- Supplied with two (2) 1/4" dia. threaded studs, spanner collar, and spanner wrench

CTC Length	14G	14H	14J	14L
Inches	8	9	10	12
Millimeters	203	229	254	305





PULLS



19N

Cast Pull

Certification: Meets ANSI A156.6 for J401 Pulls
 O/A Height: 9" (229 mm)
 Base Diameter: 1-1/2" (38 mm)
 Projection: 3-1/8" (79 mm)
 CTC Length: 6-3/16" (132 mm)
 Materials: Brass
 Finishes: US3, US10, US10B, US26, US26D
 Fasteners: Four (4) #8 x 1" OPHWS
 Notes: Suitable for back to back mounting with sex nuts by special quotation
 Clearance: 1-11/16" (43 mm)



20

Round Push/Pull Set

Certification: Meets ANSI A156.6 for J401 Pulls
 Base Diameter: 1-1/4" (32 mm)
 Projection: 3" (76 mm)
 Clearance: 1-3/4" (45 mm)
 Door Thickness: 1-3/4" (45 mm) - 2-1/8" (54 mm) Standard
 Materials: Brass, bronze, stainless steel
 Finishes: US3, US4, US10, US10B, US26, US26D, US28, US32, US32D
 Notes:

CTC Length	20L	20Q
Inches	12	18
Millimeters	305	457

- Type 7 mounting - Standard
- Consists of two (2) pulls back to back
- For sizes or finishes not listed in this catalog, contact Hager Customer Service for availability
- Supplied with two (2) 5/16" dia. threaded studs, spanner collar, and spanner wrench



20N

Cast Pull

Certification: Meets ANSI A156.6 for J401 Pulls
 O/A Height: 9" (229 mm)
 Base Diameter: 1-1/2" (38 mm)
 Projection: 3-1/8" (79 mm)
 CTC Length: 5-7/32" (132.5 mm)
 Door Thickness: 1-3/4" - Standard
 Material: Brass
 Finishes: US3, US10, US10B, US26, US26D
 Fasteners: Two (2) 1/4 - 20 x 2-3/16" undercut FPHMS with finish washers
 Clearance: 1-11/16" (43 mm)



21

Round Offset Push/Pull Set

Certification: Meets ANSI A156.6 for J402 Pulls
 Base Diameter: 3/4" (19 mm)
 Projection: 2-1/2" (64 mm)
 Clearance: 1-3/4" (45 mm)
 Offset: 2-1/2" (64); 90° - Standard
 Door Thickness: 1-3/4" (45 mm) - 2-1/8" (54 mm) Standard
 Materials: Aluminum, brass, bronze, stainless steel
 Finishes: US3, US4, US10, US10B, US26, US26D, US28, US32, US32D
 Notes:

CTC Length	21E	21G	21J	21L
Inches	6	8	10	12
Millimeters	152	203	254	305

- Type 7 mounting - Standard
- Consists of two (2) pulls back to back
- Available with 45 degree offset
- For sizes or finishes not listed in this catalog, contact Hager Customer Service for availability
- Supplied with two (2) 1/4" dia. threaded studs, spanner collar, and spanner wrench



PULLS



22

Round Offset Push/Pull Set

Certification: Meets ANSI A156.6 for J402 Pulls
 Base Diameter: 1" (25 mm)
 Projection: 2-3/4" (70 mm)
 Clearance: 1-3/4" (45 mm)
 Door Thickness: 1-3/4" (45 mm) - 2-1/18" (54 mm) Standard
 Offset: 3" (76 mm); 90° standard
 Materials: Aluminum, brass, bronze, stainless steel
 Finishes: US3, US4, US10, US10B, US26, US26D, US28, US32, US32D
 Notes:

- Type 7 mounting - Standard
- Consists of two (2) pulls back to back
- Available with 45 degree offset
- For sizes or finishes not listed in this catalog, contact Hager Customer Service for availability
- Supplied with two (2) 1/4" dia. threaded studs, spanner collar, and spanner wrench

CTC Length	22G	22J	22L
Inches	8	10	12
Millimeters	203	254	305



23Q

Round Offset Pull

Certification: Meets ANSI A156.6 for J402 Offset Pulls
 Base Diameter: 1-1/4" (32 mm)
 Projection: 3" (76 mm)
 Clearance: 1-3/4" (45 mm)
 Offset: 3-3/4" (96 mm); 90° Standard
 Door Thickness: 1-3/4" (45 mm) - Standard
 CTC Length: 18" (457 mm)
 Materials: Aluminum, brass, bronze, stainless steel
 Finishes: US3, US4, US10, US10B, US26, US26D, US28, US32, US32D
 Fasteners: 5/16-18 x 2-1/4" FPHMS with finish washers
 Handicap:

- 2-1/2" (64 mm) clearance available on special orders
 - Add prefix "H" to number (i.e., H23Q)
- Options: For 45° offset, substitute "X" for first digit (i.e., X23Q)
- Notes:
- If ordered with tempered glass, specify glass thickness and hole size
 - For sizes or finishes not listed in this catalog, contact Hager Customer Service for availability



24Q

Round Offset Push/Pull Set

Certification: Meets ANSI A156.6 for J402 Offset Pulls
 Base Diameter: 1-1/4" (32 mm)
 Projection: 3" (76 mm)
 Clearance: 1-3/4" (45 mm)
 Offset: 3-3/4" (95 mm); 90° standard
 Door Thickness: 1-3/4" (45 mm) - 2-1/18" (54 mm) Standard
 CTC Length: 18" (457 mm)
 Materials: Aluminum, brass, bronze, stainless steel
 Finishes: US3, US4, US10, US10B, US26, US26D, US28, US32, US32D
 Notes:

- Type 7 mounting - Standard
- Consists of two (2) pulls back to back
- Available with 45 degree offset
- For sizes or finishes not listed in this catalog, contact Hager Customer Service for availability
- Supplied with two (2) 5/16" dia. threaded studs, spanner collar, and spanner wrench





PULLS



910P | 910B

Offset Mounting Vertical Pull

Pull Diameter:	1-1/4" (32 mm)
O/A Length:	36" (914 mm), 72" (1829 mm)
CTC Lengths:	20" (508 mm), 56" (1422 mm)
Materials:	Aluminum, brass, bronze, stainless steel tubing
Finishes:	US3, US4, US10, US10B, US15A, US26, US26D, US28, US32D
Fasteners:	Two (2) 3/8-16 FPHMS with finish washers
Notes:	<ul style="list-style-type: none"> • 910B is same as 910P with fasteners for back to back mounting • For sizes or finishes not listed in this catalog, contact Hager Customer Service for availability
Clearance:	1-1/2" (38 mm)
Projection:	2-3/4" (70 mm)
Offset:	1-5/8" (41 mm)



915P | 915B

Straight Mounting Vertical Pull

Pull Diameter:	1-1/4" (32 mm)
O/A Length:	36" (914 mm), 72" (1829 mm)
CTC Lengths:	20" (508 mm), 56" (1422 mm)
Materials:	Aluminum, brass, bronze, stainless steel tubing
Finishes:	US3, US4, US10, US10B, US15A, US26, US26D, US28, US32D
Fasteners:	Two (2) 3/8-16 FPHMS w/ finish washers
Notes:	<ul style="list-style-type: none"> • 915B is same as 915P with fasteners for back to back mounting • For sizes or finishes not listed in this catalog, contact Hager Customer Service for availability
36" and 20"	
Clearance:	2" (51 mm)
Projection:	3-1/4" (83 mm)
72" and 56"	
Clearance:	1-1/2" (38 mm)
Projection:	2-3/4" (70 mm)



PULLS



920P | 920B

C-Shaped Pull

- Base Diameter: 1" (25 mm)
 Clearance: 1-3/4" (45 mm)
 Projection: 2-1/4" (57 mm)
 CTC Length: 8-1/2" (217 mm)
 Materials: Aluminum, brass, bronze, stainless steel
 Finishes: US3, US4, US10, US10B, US15A, US26, US26D, US28, US32D
 Fasteners: Two (2) 3/8-16 FPHMS with finish washers
 Notes:
 - 920B is pair of 920P with fasteners for back to back mounting
 - For sizes or finishes not listed in this catalog, contact Hager Customer Service for availability



921P | 921B

C-Shaped Pull

- Clearance: 1-1/2" (38 mm)
 Offset: 8-1/2" (216 mm)
 Projection: 2-1/8" (54 mm)
 CTC Length: 17-1/2" (446 mm)
 Materials: Brass, bronze, stainless steel
 Finishes: US3, US4, US10, US10B, US15A, US26, US26D, US32D
 Fasteners: Two (2) 3/8-16 FPHMS with finish washers
 Notes:
 - 921B is pair of 921P with fasteners for back to back mounting
 - For sizes or finishes not listed in this catalog, contact Hager Customer Service for availability



922P | 922B

C-Shaped Pull - Continuous

- Pull Diameter: 1" (25 mm)
 Projection: 2-1/2" (64 mm)
 CTC Lengths: 10" (254 mm), 12" (305 mm)
 Clearance: 1-1/2" (38 mm)
 Materials: Aluminum, brass, bronze, stainless steel
 Finishes: US3, US4, US10, US10B, US15A, US26, US26D, US28, US32D
 Fasteners: Two (2) 3/8-16 FPHMS with finish washers
 Notes:
 - 922B is pair of 922P with fasteners for back to back mounting
 - For sizes or finishes not listed in this catalog, contact Hager Customer Service for availability



923P | 923B

C-Shaped Pull - Flanged

- Pull Diameter: 1" (25 mm)
 Projection: 2-3/4" (70 mm)
 CTC Lengths: 10" (254 mm), 12" (305 mm)
 Clearance: 1-3/4" (44 mm)
 Base Diameter: 3/4" (19 mm)
 Materials: Aluminum, brass, bronze, stainless steel
 Finishes: US3, US4, US10, US10B, US15A, US26, US26D, US28, US32D
 Fasteners: Two (2) 3/8-16 FPHMS with finish washers
 Notes:
 - 923B is pair of 923P with fasteners for back to back mounting
 - For sizes or finishes not listed in this catalog, contact Hager Customer Service for availability





PULLS



924P | 924B C-Shaped Pull

Projection: 2-1/2" (64 mm)
 CTC Length: 14" (356 mm)
 Clearance: 1-1/2" (38 mm)
 Offset: 6-1/2" (165 mm)
 Materials: Brass, bronze, stainless steel
 Finishes: US3, US4, US10B, US15A, US26, US26D, US32D
 Fasteners: Two (2) 3/8-16 FPHMS with finish washers
 Notes:

- 924B is pair of 924P with fasteners for back to back mounting
- For sizes or finishes not listed in this catalog, contact Hager Customer Service for availability



925P | 925B C-Shaped Pull

Pull Diameter: 1-1/4" (32 mm)
 CTC Lengths: 6-1/2" (165 mm), 8-1/2" (217 mm), 12-1/2" (318 mm)
 Materials: Aluminum, brass, bronze, stainless steel
 Finishes: US3, US4, US10B, US15A, US26, US26D, US28, US32D
 Fasteners: Two (2) 3/8-16 FPHMS with finish washers
 Notes:

- 925B is pair of 925P with fasteners for back to back mounting
- For sizes or finishes not listed in this catalog, contact Hager Customer Service for availability



926P | 926B Curved Pull

Base Diameter: 1-1/4" (32 mm)
 Projection: 3" (76 mm)
 Clearance: 1-13/16" (46 mm)
 Offset: 5-9/32" (134 mm)
 Pull Diameter: 1-3/16" (30 mm)
 CTC Length: 12" (305 mm)
 Materials: Brass, bronze
 Finishes: US3, US4, US10, US10B
 Fasteners: Two (2) 3/8-16 FPHMS with finish washers
 Notes:

- 926B is pair of 926P with fasteners for back to back mounting
- For sizes or finishes not listed in this catalog, contact Hager Customer Service for availability



930P | 930B 90° Pull

Projection: 3" (76 mm)
 Clearance: 1-3/4" (45 mm)
 CTC Lengths: 14-5/32" - 16-31/32" (360 mm - 431 mm)
 Materials: Aluminum, brass, bronze, stainless steel
 Finishes: US3, US4, US10B, US15A, US26, US26D, US28, US32D
 Fasteners: Two (2) 3/8-16 FPHMS with finish washers
 Notes:

- 930B is pair of 930P with fasteners for back to back mounting
- For sizes or finishes not listed in this catalog, contact Hager Customer Service for availability



PULLS



932P | 932B
S-Shaped Pull

Projection: 3" (76 mm)
 Clearance: 2" (51 mm)
 Pull Diameter: 1" (25 mm)
 Fasteners: Two (2) 3/8-16 FPHMS w/ finish washers
 CTC Length: 30" (762 mm)
 Materials: Aluminum, brass, bronze, stainless steel
 Finishes: US3, US4, US10B, US15A, US26, US26D, US28, US32D
 Fasteners: Two (2) 3/8-16 FPHMS with finish washers
 Notes:

- 932B is pair of 932P with fasteners for back to back mounting
- Specify handing when ordering
- For sizes or finishes not listed in this catalog, contact Hager Customer Service for availability



933P | 933B
Colonial Style Pull

Projection: 2-3/16" (56 mm)
 Clearance: 1-3/16" (30 mm)
 Pull Diameter: 1" (25 mm)
 Base Diameter: 15/16" (24 mm)
 CTC Length: 6" (152 mm)
 Materials: Brass and bronze
 Finishes: US3, US4, US10B, US26
 Fasteners: Two (2) 3/8-16 FPHMS with finish washers
 Notes: 933B is pair of 933P with fasteners for back to back mounting



934P | 934B
Offset Pull

Projection: 3-1/8" (80 mm)
 Clearance: 1-7/8" (48 mm)
 Pull Diameter: 1-1/4" (32 mm)
 Base Diameter: 1" (25 mm)
 CTC Lengths: 12" (305 mm), 16" (406 mm), 18" (457 mm)
 Materials: Aluminum, brass, bronze, stainless steel
 Finishes: US3, US4, US10B, US15A, US26, US26D, US28, US32D
 Fasteners: Two (2) 3/8-16 FPHMS with finish washers
 Notes: 934B is pair of 934P with fasteners for back to back mounting



960P | 960B
Square Tip Pull

O/A Height: 16" (406 mm)
 Base Diameter: 1-1/4" (32 mm)
 Pull Diameter: 1" (25 mm)
 Clearance: 1-3/4" (45 mm)
 Projection: 3-1/4" (83 mm)
 CTC Length: 12" (305 mm)
 Materials: Brass, bronze
 Finishes: US3, US4, US10B, US15A, US26, US26D
 Fasteners: Two (2) 3/8-16 FPHMS w/ finish washers
 Notes:

- 960B is pair of 960P with fasteners for back to back mounting
- For sizes or finishes not listed in this catalog, contact Hager Customer Service for availability





PULLS



961P | 961B

Steeple Tip Pull

- O/A Height: 16-5/16" (414 mm)
 Base Diameter: 2" (51 mm)
 Pull Diameter: 1" (25 mm)
 Clearance: 1-3/4" (45 mm)
 Projection: 3" (76 mm)
 CTC Length: 12" (305 mm)
 Materials: Brass, bronze
 Finishes: US3, US4, US10B, US15A, US26, US26D
 Fasteners: Two (2) 3/8-16 FPHMS with finish washers
 Notes:
 - 961B is pair of 961P with fasteners for back to back mounting
 - For sizes or finishes not listed in this catalog, contact Hager Customer Service for availability



962P

Acorn Tip Pull

- O/A Height: 16-5/16" (414 mm)
 Base Diameter: 2" (51 mm)
 Pull Diameter: 1" (25 mm)
 Projection: 3" (76 mm)
 Clearance: 1-7/8" (48 mm)
 CTC Length: 12" (305 mm)
 Materials: Brass, bronze
 Finishes: US3, US4, US10B, US15A, US26, US26D
 Fasteners: Two (2) 3/8-16 FPHMS with finish washers
 Notes: For sizes or finishes not listed in this catalog, contact Hager Customer Service for availability



963P

Acorn Pull - Offset

- O/A Height: 16-5/16" (414 mm)
 Pull Diameter: 1" (25 mm)
 Projection: 2-3/4" (70 mm)
 CTC Lengths: 12" (304 mm), 16" (406 mm), 18" (457 mm), 24" (610 mm), 30" (762 mm)
 Materials: Cast brass, bronze
 Finishes: US3, US4, US10B, US15A, US26, US26D
 Fasteners: Two (2) 3/8-16 FPHMS with finish washers
 Notes: For sizes or finishes not listed in this catalog, contact Hager Customer Service for availability



967P

Curved Pull

- O/A Height: 20-1/2" (520 mm)
 Projection: 5-9/16" (141 mm)
 Clearance: 3-9/16" (90 mm)
 CTC Length: 16" (406 mm)
 Materials: Brass, bronze
 Finishes: US3, US4, US10B, US15A, US26, US26D
 Fasteners: Two (2) 3/8-16 FPHMS with finish washers
 Notes: For sizes or finishes not listed in this catalog, contact Hager Customer Service for availability



PULLS



970P

Custom Push/Pull Set

Base Diameter: 1" (25 mm)
 Pull Projection: 3" (76 mm)
 Pull Clearance: 2" (51 mm)
 CTC Length: 13-1/4" (337 mm)
 Push Projection: 2-3/4" (70 mm)
 Push Clearance: 1-3/4" (45 mm)
 CTC Length: 34" (864 mm) or to suit door dimension
 Materials: Brass, bronze, stainless steel
 Finishes: US3, US4, US10, US10B, US15A, US26, US26D, US32D
 Fasteners: 3/8 x 16 Type 3 mounting, concealed cone with 3/8 x 16 Type 2 thru bolts and finish washer; Type 1, thru-bolt, finish washer mount for free ends

Notes:

- Pull or push bar can be ordered separately by quotation only
- Push bar radius can be custom made so the radius points in the downward direction
- For sizes or finishes not listed in this catalog, contact Hager Customer Service for availability



974P | 974B

Door Pull

Projection: 2-1/2" (64 mm)
 CTC Length: 12" (304 mm), 18" (457 mm), 24" (610 mm), 30" (762 mm), 36" (914 mm), 48" (1219 mm)

Materials: Brass, bronze, stainless steel
 Finishes: US3, US4, US10B, US26, US26D, US32D
 Fasteners: Two (2) 3/8-16 FPHMS with finish washers

Notes:

- 974B is pair of 974P with fasteners for back to back mounting
- For sizes or finishes not listed in this catalog, contact Hager Customer Service for availability



975P | 975B

Vertical Pull

Projection: 2-3/4" (70 mm)
 O/A Length: 36" (914 mm), 72" (1829 mm)
 CTC Length: 20" (508 mm), 56" (1422 mm)
 Pull Diameter: 1" (25 mm)

Materials: Brass, bronze, stainless steel
 Finishes: US3, US4, US10, US10B, US15A, US26, US26D, US32D
 Fasteners: Two (2) 3/8-16 FPHMS with finish washers

Notes:

- 975B is pair of 975P with fasteners for back to back mounting
- For sizes or finishes not listed in this catalog, contact Hager Customer Service for availability





PULLS



976P | 976B

Door Pull - Offset

O/A Height: 29-1/2" (750 mm)
 Base Diameter: 1-1/4" (32 mm)
 Pull Diameter: 1-1/4" (32 mm)
 Projection: 5-3/8" (137 mm)
 Clearance: 4-1/8" (105 mm)
 Offset: 1-3/4" (45 mm)
 CTC Length: 19-13/16" (503 mm)
 Materials: Stainless steel
 Finish: US32D
 Fasteners: Two (2) 3/8-16 FPHMS with finish washers
 Notes:

- 976B is pair of 976P with fasteners for back to back mounting
- For sizes or finishes not listed in this catalog, contact Hager Customer Service for availability



980P | 980B

Segment Shape - Straight

CTC Length: 9" (229 mm), 12" (305 mm), 18" (457 mm), 24" (610 mm)
 Materials: Brass, bronze, stainless steel
 Finishes: US3, US4, US10B, US15A, US26, US26D, US32D
 Fasteners: Two (2) 3/8-16 FPHMS with finish washers
 Notes:

- 980B is pair of 980P with fasteners for back to back mounting
- For sizes or finishes not listed in this catalog, contact Hager Customer Service for availability



981P | 981B

Segment Shape - Offset

Projection: 2-3/8" (60 mm)
 CTC Length: 9" (229 mm), 12" (305 mm), 18" (457 mm), 24" (610 mm)
 Materials: Brass, bronze, stainless steel
 Finishes: US3, US4, US10B, US15A, US26, US26D, US32D
 Fasteners: Two (2) 3/8-16 FPHMS with finish washers
 Notes:

- 981B is pair of 981P with fasteners for back to back mounting
- For sizes or finishes not listed in this catalog, contact Hager Customer Service for availability



982P | 982B

Straight Pull

Base Diameter: 1-5/16" (33 mm)
 Projection: 3-1/8" (79 mm)
 Clearance: 1-13/16" (46 mm)
 CTC Length: 20" (508 mm)
 Materials: Brass, bronze, stainless steel
 Finishes: US3, US4, US10B, US15A, US26, US26D, US32D
 Fasteners: Two (2) 3/8-16 FPHMS with finish washers
 Notes:

- 982B is pair of 982P with fasteners for back to back mounting
- For sizes or finishes not listed in this catalog, contact Hager Customer Service for availability

PULLS



983P | 983B

Curved Pull

O/A Height:	21-1/4" (540 mm)
Base Diameter:	1-1/4" (32 mm)
Projection:	3-1/8" (79 mm)
Clearance:	1-7/8" (48 mm)
CTC Length:	20" (508 mm)
Materials:	Brass, bronze, stainless steel
Finishes:	US3, US4, US10B, US15A, US26, US26D, US32D
Fasteners:	Two (2) 3/8-16 FPHMS with finish washers
Notes:	<ul style="list-style-type: none"> • 983B is pair of 983P with fasteners for back to back mounting • Specify handing when ordering • For sizes or finishes not listed in this catalog, contact Hager Customer Service for availability



984P | 984B

Curved Pull

Projection:	3" (76 mm)
CTC Lengths:	12" (305 mm), 20" (508 mm)
Materials:	Brass, bronze, stainless steel
Finishes:	US3, US4, US10B, US15A, US26, US32, US32D
Fasteners:	Two (2) 3/8-16 FPHMS with finish washers
Notes:	<ul style="list-style-type: none"> • 984B is pair of 984P with fasteners for back to back mounting • For sizes or finishes not listed in this catalog, contact Hager Customer Service for availability



985P | 985B

Curved Pull

O/A Height:	14" (356 mm)
Base Diameter:	2" (51 mm)
Projection:	3" (76 mm)
Clearance:	1-9/16" (40 mm)
Offset:	1-5/8" (41 mm)
CTC Length:	12" (305 mm)
Materials:	Brass, bronze, stainless steel
Finishes:	US3, US4, US10B, US15A, US26, US26D, US32D
Fasteners:	Two (2) 3/8-16 FPHMS with finish washers
Notes:	<ul style="list-style-type: none"> • 985B is pair of 985P with fasteners for back to back mounting • For sizes or finishes not listed in this catalog, contact Hager Customer Service for availability



986P | 986B

Curved Pull

O/A Height:	22" (559 mm)
Pull Diameter:	1-1/4" (32 mm)
Base Diameter:	2" (51 mm)
Projection:	3-7/8" (99 mm)
Clearance:	2-5/8" (67 mm)
Offset:	3" (76 mm)
CTC Length:	20" (508 mm)
Materials:	Brass, bronze, stainless steel
Finishes:	US3, US4, US10B, US15A, US26, US26D, US32
Fasteners:	Two (2) 3/8-16 FPHMS with finish washers
Notes:	<ul style="list-style-type: none"> • 986B is pair of 986P with fasteners for back to back mounting • For sizes or finishes not listed in this catalog, contact Hager Customer Service for availability





PULLS



987P | 987B Double Curved Pull

Base Diameter: 1-1/4" (32 mm)

Projection: 3" (76 mm)

Clearance: 2" (51 mm)

CTC Length: 20" (508 mm)

Materials: Brass, bronze, stainless steel

Finishes: US3, US4, US10B, US15A, US26, US26D, US32D

Fasteners: Two (2) 3/8-16 FPHMS with finish washers

Notes:

- 987B is pair of 987P with fasteners for back to back mounting
- For sizes or finishes not listed in this catalog, contact Hager Customer Service for availability



988P | 988B Offset Pull

Projection: 3" (76 mm)

CTC Length: 24" (610 mm)

Materials: Brass, bronze, stainless steel

Finishes: US3, US26, US32D

Fasteners: Two (2) 3/8-16 FPHMS with finish washers

Notes:

- 988B is pair of 988P with fasteners for back to back mounting
- For sizes or finishes not listed in this catalog, contact Hager Customer Service for availability



990P | 990B 18° Pull

Pull Diameter: 1" (25 mm)

Projection: 2-3/4" (70 mm)

Clearance: 1-3/4" (45 mm)

CTC Length: 24" (610 mm)

Materials: Brass, bronze, stainless steel

Finishes: US3, US4, US10B, US15A, US26, US26D, US32D

Fasteners: Two (2) 3/8-16 FPHMS with finish washers

Notes:

- 990B is pair of 990P with fasteners for back to back mounting
- Specify handing when ordering
- For sizes or finishes not listed in this catalog, contact Hager Customer Service for availability

FLUSH CUP PULLS



15C

Heavy Duty Flush Cup Pull

Certification: Meets ANSI A156.6 for J403 Pulls
 Description: Cup welded to face plate
 Face: 3-1/2" x 5" (89 mm x 127 mm)
 Projection: 1/8" (3.2 mm)
 Opening: 1-3/4" x 3-1/16" (44 mm x 78 mm)
 Cup Clearance: 3/4" (19 mm)
 Materials: Stainless steel
 Finishes: US32D
 Fasteners: Four (4) #6 x 5/8" OPHWS



15N

Flush Cup Pull

Certification: Meets ANSI A156.6 for J403 Pulls
 Description: Cup welded to face plate
 Face: 3-1/2" x 5" (89 mm x 127 mm)
 Projection: 1/8" (3.2 mm)
 Opening: 1-3/4" x 3-1/16" (44 mm x 78 mm)
 Cup Clearance: 3/4" (19 mm)
 Materials: Aluminum, brass, bronze, stainless steel
 Finishes: US3, US4, US10, US10B, US26, US26D, US28, US32D
 Fasteners: Four (4) #6 x 5/8" OPHWS



15P

Heavy Duty Security Flush Cup Pull

Certification: Meets ANSI A156.6 for J403 Pulls
 Description: Cup welded to face plate and welded studs for security torx thru-bolt mounting
 Face: 3-1/2" x 5" (89 mm x 127 mm)
 Projection: 1/8" (3.2 mm)
 Opening: 1-3/4" x 3-1/16" (44 mm x 78 mm)
 Cup Clearance: 3/4" (19 mm)
 Materials: Stainless steel
 Finishes: US32D
 Fasteners: Two (2) 6-32 x 1-1/2" FPHMS (Security Torx)
 Notes: For use on 1-3/4" (44 mm) doors



15S

Light Duty Flush Cup Pull

Certification: Meets ANSI A156.6 for J403 Pulls
 Description: Concealed mounting by screws within the recessed cup (similar to 16N or 17N)
 Face: 3-1/2" x 5" (89 mm x 127 mm)
 Projection: 1/8" (3.2 mm)
 Opening: 1-3/4" x 3-1/16" (44 mm x 78 mm)
 Cup Clearance: 3/4" (19 mm)
 Materials: Aluminum, brass, bronze, stainless steel
 Finishes: US3, US4, US10, US10B, US26, US26D, US28, US32D
 Fasteners: Two (2) #6 x 5/8" PPHWS
 Notes: Fasteners concealed in cup





FLUSH CUP PULLS



16N

Light Duty Flush Cup Pull

Certification: Meets ANSI A156.6 for J403 Pulls
 Face: 1-15/16" x 3" (49 mm x 76 mm)
 Projection: 1/16" (1.5 mm)
 Opening: 27/32" x 2-3/8" (22 mm x 60 mm)
 Cup Clearance: 5/8" (16 mm)
 Materials: Brass
 Finishes: US3, US4, US10, US10B, US26, US26D
 Fasteners: Two (2) #8 x 3/4" OPHWS
 Notes: Fasteners concealed in cup



16R

Finger Pull Plate

Certification: Meets ANSI A156.6 for combination J301 Pull Plate and J403 Pulls
 Face: 4" x 16" (102 mm x 406 mm)
 Projection: .050" (1.3 mm)
 Opening: 1-3/4" x 3-1/16" (44 x 78 mm)
 Cup Clearance: 13/16" (21 mm)
 Materials: Aluminum, brass, bronze, stainless steel
 Finishes: US3, US4, US10, US10B, US26, US26D, US28, US32, US32D
 Fasteners: Ten (10) #6 x 5/8" OPHWS



17N

Light Duty Flush Cup Pull

Certification: Meets ANSI A156.6 for J403 Pulls
 Face: 2-1/2" x 3-31/32" (64 mm x 101 mm)
 Projection: 3/32" (2.4 mm)
 Opening: 1-11/32" x 3-13/32" (34 mm x 87 mm)
 Cup Clearance: 5/8" (16 mm)
 Materials: Brass
 Finishes: US3, US4, US10, US10B, US26, US26D
 Fasteners: Two (2) #8 x 13/16" OPHWS
 Notes: Fasteners concealed in cup



25B

Security Flush Pull Set

Certification: Meets ANSI A156.6 for J403 Pulls
 Face: 3-1/2" x 5" (89 mm x 127 mm)
 Opening: 1-3/4" x 3-1/16" (45 mm x 78 mm)
 Projection: 3/16" (5 mm)
 Cup Clearance: 3/4" (19 mm)
 Door Thickness: 1-3/4" (45 mm) - Standard
 Materials: Stainless steel
 Finishes: US32D
 Fasteners: Two (2) 6-32 x 1-1/2" FPHMS (Security Torx)
 Notes: Security pull thru-bolted to a 15P pull

FLUSH CUP PULLS



25C

Heavy Duty Flush Pull Set

Certification: Meets ANSI A156.6 for J403 Pulls
 Face: 3-1/2" x 5" (89 mm x 127 mm)
 Opening: 1-3/4" x 3-1/16" (45 mm x 78 mm)
 Projection: 1/8" (3 mm)
 Cup Clearance: 3/4" (19 mm)
 Door Thickness: 1-3/4" (45 mm) - Standard
 Materials: Stainless steel
 Finishes: US32D
 Fasteners: Two (2) 6-32 OPHMS sex nuts and bolts
 Notes: Consists of two (2) 15C pulls mounted back to back



25N

Flush Pull Set

Certification: Meets ANSI A156.6 for J403 Pulls
 Face: 3-1/2" x 5" (89 mm x 127 mm)
 Opening: 1-3/4" x 3-1/16" (45 mm x 78 mm)
 Projection: 1/8" (3 mm)
 Cup clearance: 3/4" (19 mm)
 Door Thickness: 1-3/4" (45 mm) - Standard
 Materials: Aluminum, brass, bronze, stainless steel
 Finishes: US3, US4, US10, US10B, US26, US26D, US28, US32D
 Fasteners: Two (2) 6-32 OPHMS sex nuts and bolts
 Notes: Consists of two (2) 15N pulls mounted back to back



25P

Security Finger Push/Pull Plate Set

Certification: Meets ANSI A156.6 for combination J301 Push Plate and J403 Flush Pull
 Face: 4" x 16" (102 mm x 406 mm)
 Projection: 1/8" (3.2 mm)
 Opening: 1-3/4" x 3-1/16" (44 mm x 78 mm)
 Cup Clearance: 13/16" (21 mm)
 Materials: Stainless steel
 Finishes: US32D
 Fasteners: Six (6) 8-32 x 3/4" FPHMS (Security Torx) with sex nuts and bolts
 Notes: Consists of a 15 pull cup welded to a 100T push plate (Mounted in back to back fashion)



26N

Security Finger Pull

Certification: Meets ANSI A156.6 for J403 Pulls
 Face: 4" x 5" (102 mm x 127 mm)
 Projection: 1/8" (3.2 mm)
 Opening: 1-5/8" x 3" (41 mm x 76 mm)
 Cup Clearance: 13/16" (21 mm)
 Materials: Brass, stainless steel
 Finishes: US4, US26D, US32D
 Fasteners: Four (4) 1/4-20 x 3/4" Undercut FPHMS (Security Torx)
 Notes: Cup welded to face





FLUSH CUP PULLS



27N

Security Flush Cup Pull

Certification: Meets ANSI A156.6 for J403 Pulls
Face: 5" x 5" (127 mm x 127 mm)
Projection: 3/8" (9.5 mm)
Opening: 3" x 3-1/2" (76 mm x 89 mm)
Cup Clearance: 7/8" (22 mm)
Materials: Stainless steel
Finishes: US32D
Fasteners: Four (4) 10-24 FPHMS (Security Torx) sex nuts and bolts (compatible with 1-3/4" doors only)
Notes:

- ADA Compliant
- Not available for back to back mounting



27P

Security Flush Cup Pull

Certification: Meets ANSI A156.6 for J403 Pulls
Face: 5" x 5" (127 mm x 127 mm)
Projection: 3/8" (9.5 mm)
Opening: 3" x 3-1/2" (76 mm x 89 mm)
Cup Clearance: 7/8" (22 mm)
Materials: Stainless steel
Finishes: US32D
Fasteners: Four (4) 1/4-20 x 3/4" Undercut FPHMS (Security Torx)
Notes:

- ADA Compliant
- Not available for back to back mounting

PULL PLATES



30, 40, 50 Series Pull Plate

Gauge: 0.050" (1.3 mm)
Certification: Meets ANSI A156.6 for J405 Pull Plate



A30, A40, A50 Series Pull Plate

Gauge: 0.062" (1.6 mm)
Certification: Meets ANSI A156.6 for J405 Pull Plate



80, 90, 100 Series Pull Plate

Gauge: 0.125" (3.2 mm)
Certification: Meets ANSI A156.6 for J407 Pull Plate

Materials: Aluminum, brass, bronze, stainless steel
Standard Sizes: 3" x 12" (76 mm x 305 mm), 3-1/2" x 15" (89 mm x 381 mm), 4" x 16" (102 mm x 406 mm), 6" x 16" (152 mm x 406 mm)*, 8" x 16" (203 mm x 406 mm)* - *(size not available for 50 and A50 Series)

Fasteners: Six (6) #6 x 5/8 OPH tapping screws
Finishes: US3, US4, US10, US10B, US26, US26D, US28, US32, US32D and diamond tread – available for the A30 in US26 only

Notes:

- For sizes or finishes not listed in this catalog, contact Hager Customer Service for availability
- Plate only - does not include pull

How To Order:

- 1) Identify plate (ex: 30 Series)
- 2) Add pull (ex.: 3G)
- 3) Add to order (ex: 33G)

Pull Plate Chart									
Pull	30, 40, 50 Series			A30, A40, A50 Series			80, 90, 100 Series		
	Square Corner	Radius Corner	Rounded Corner	Square Corner	Radius Corner	Rounded Corner	Square Corner	Radius Corner	Rounded Bevel
Pull Plate Part Number									
1E	31E	41E	51E	A31E	A41E	A51E	81E	91E	101E
1G	31G	41G	51G	A31G	A41G	A51G	81G	91G	101G
1J	31J	41J	51J	A31J	A41J	A51J	81J	91J	101J
1L	31L	41L	51L	A31L	A41L	A51L	81L	91L	101L
2E	32E	42E	52E	A32E	A42E	A52E	82E	92E	102E
2G	32G	42G	52G	A32G	A42G	A52G	82G	92G	102G
2J	32J	42J	52J	A32J	A42J	A52J	82J	92J	102J
2L	32L	42L	52L	A32L	A42L	A52L	82L	92L	102L
3E	33E	43E	53E	A33E	A43E	A53E	83E	93E	103E
3G	33G	43G	53G	A33G	A43G	A53G	83G	93G	103G
3J	33J	43J	53J	A33J	A43J	A53J	83J	93J	103J
3L	33L	43L	53L	A33L	A43L	A53L	83L	93L	103L
4G	34G	44G	54G	A34G	A44G	A54G	84G	94G	104G
4J	34J	44J	54J	A34J	A44J	A54J	84J	94J	104J
4L	34L	44L	54L	A34L	A44L	A54L	84L	94L	104L
5D	35D	45D	55D	A35D	A45D	A55D	85D	95D	105D
5N	35N	45N	55N	A35N	A45N	A55N	85N	95N	105N
6N	36N	46N	56N	A36N	A46N	A56N	86N	96N	106N
9E	39E	49E	59E	A39E	A49E	A59E	89E	99E	109E
9G	39G	49G	59G	A39G	A49G	A59G	89G	99G	109G
9J	39J	49J	59J	A39J	A49J	A59J	89J	99J	109J
9L	39L	49L	59L	A39L	A49L	A59L	89L	99L	109L





PULL PLATES



313L

Antivandal Trim with Latchguard

- Certification: Meets ANSI A156.6 for J401 Pull and ANSI A156.6 for J407 Pull Plate
 Size: 7-13/32" x 11" (188 mm x 280 mm)
 Height: 11" (280 mm)
 Projection: 1-7/8" (48 mm)
 Clearance: 1-5/8" (41 mm)
 Door Thickness: 1-3/4" – 2" (45 mm - 51 mm)
 Materials: 11 gauge stainless steel
 Finishes: US32D
 Fasteners: 1/4-20 FPHMS with finish washers - Standard
 Options:
 - Cylinder cutout available - 1-1/4" (32 mm) diameter standard for exit device use and 1-1/2" (38 mm) diameter standard for mortise lock use
 - Plastisol grip available
 Notes:
 - For use with most mortise locks on out-swinging doors
 - For use with many exit devices (thru bolts directly to device)
 - Cylinders must be ordered separately
 - When mounting trim to a Hager exit device, cylinder collar (2-649-0137) must be purchased to ensure proper installation (see instructions for more detail)
 - When mounting trim to a Hager exit device, a 7/16" (11 mm) tall cylinder collar must be purchased when using a 1-1/4" - 1-3/8" (32 mm - 35 mm) long rim cylinder (see instructions for more detail)



313S

Antivandal Trim

- Certification: Meets ANSI A156.6 for J401 Pull and ANSI A156.6 for J407 Pull Plate
 Size: 6-11/32" x 11" (161 mm x 280 mm)
 Height: 11" (280 mm)
 Projection: 1-7/8" (48 mm)
 Clearance: 1-5/8" (41 mm)
 Door Thickness: 1-3/4" – 2" (45 mm - 51 mm)
 Materials: 11 gauge stainless steel
 Finishes: US32D
 Fasteners: 1/4-20 FPHMS with finish washers - Standard
 Options:
 - Cylinder cutout available - 1-1/4" (32 mm) diameter standard for exit device use and 1-1/2" (38 mm) diameter standard for mortise lock use
 - Plastisol grip available
 Notes:
 - For use with most mortise locks on in-swinging and out-swinging doors
 - For use with many exit devices (thru bolts directly to device)
 - Cylinders must be ordered separately
 - When mounting trim to a Hager exit device, cylinder collar (2-649-0137) must be purchased to ensure proper installation (see instructions for more detail)
 - When mounting trim to a Hager exit device, a 7/16" (11 mm) tall cylinder collar must be purchased when using a 1-1/4" - 1-3/8" (32 mm - 35 mm) long rim cylinder (see instructions for more detail)

PUSH PLATES



30S | A30S

Square Corner - Beveled Push Plate

Certification: Meets ANSI A156.6 for J301 Push Plate
 Gauge: • 30S - 0.050" (1.3 mm)
 • A30S - 0.062" (1.6 mm)
 Materials: Aluminum, brass, bronze, stainless steel
 Finishes: US3, US4, US10, US10B, US26, US26D, US28, US32, US32D
 Fasteners: Six (6) #6 x 5/8" OPH tapping screws
 Options: May be ordered cut for cylinder (CFC) or engraved "PUSH"
 Notes: For sizes or finishes not listed in this catalog, contact Hager Customer Service for availability

Available in Sizes					
Inches	3 x 12	3-1/2 x 15	4 x 16	6 x 16	8 x 16
Millimeters	76 x 305	89 x 38	102 x 406	152 x 406	203 x 406



40R | A40R

Radius Corner - Beveled Push Plate

Certification: Meets ANSI A156.6 for J301 Push Plate
 Gauge: • 40R - 0.050" (1.3 mm)
 • A40R - 0.062" (1.6 mm)
 Materials: Aluminum, brass, bronze, stainless steel
 Finishes: US3, US4, US10, US10B, US26, US26D, US28, US32, US32D
 Fasteners: Six (6) #6 x 5/8" OPH tapping screws
 Options: May be ordered cut for cylinder (CFC) or engraved "PUSH"
 Notes: For sizes or finishes not listed in this catalog, contact Hager Customer Service for availability

Available in Sizes					
Inches	3 x 12	3-1/2 x 15	4 x 16	6 x 16	8 x 16
Millimeters	76 x 305	89 x 38	102 x 406	152 x 406	203 x 406



50T | A50T

Round Corner - Beveled Push Plate

Certification: Meets ANSI A156.6 for J301 Push Plate
 Gauge: • 50T - 0.050" (1.3 mm)
 • A50T - 0.062" (1.6 mm)
 Materials: Aluminum, brass, bronze, stainless steel
 Finishes: US3, US4, US10, US10B, US26, US26D, US28, US32, US32D
 Fasteners: Six (6) #6 x 5/8" OPH tapping screws
 Options: May be ordered cut for cylinder (CFC) or engraved "PUSH"
 Notes: For sizes or finishes not listed in this catalog, contact Hager Customer Service for availability

Available in Sizes			
Inches	3 x 12	3-1/2 x 15	4 x 16
Millimeters	76 x 305	89 x 38	102 x 406





PUSH PLATES



60S

Square Corner - Beveled Push Plate

Certification: Meets ANSI A156.6 for J304 Push Plate
Gauge: 0.125" (3.2 mm)
Materials: Plastic laminate
Finishes: PG - Grey, PK - Black, CO - Brown
Fasteners: Six (6) #6 x 5/8" OPH tapping screws
Options: May be ordered cut for cylinder (CFC) or engraved "PUSH"
Notes: For sizes or finishes not listed in this catalog, contact Hager Customer Service for availability

Available in Sizes					
Inches	3 x 12	3-1/2 x 15	4 x 16	6 x 16	8 x 16
Millimeters	76 x 305	89 x 38	102 x 406	152 x 406	203 x 406



70S

Square Corner - Beveled Push Plate

Certification: Meets ANSI A156.6 for J304 Push Plate
Gauge: 0.125" (3.2 mm)
Materials: Clear plastic laminate
Finishes: PC - Clear
Fasteners: Six (6) #6 x 5/8" OPH tapping screws
Options: May be ordered cut for cylinder (CFC) or engraved "PUSH"
Notes: For sizes or finishes not listed in this catalog, contact Hager Customer Service for availability

Available in Sizes					
Inches	3 x 12	3-1/2 x 15	4 x 16	6 x 16	8 x 16
Millimeters	76 x 305	89 x 38	102 x 406	152 x 406	203 x 406



80S

Square Corner - Beveled Push Plate

Certification: Meets ANSI A156.6 for J304 Push Plate
Gauge: 0.125" (3.2 mm)
Materials: Aluminum, brass, bronze, stainless steel
Finishes: US3, US4, US10, US10B, US26, US26D, US28, US32, US32D
Fasteners: Six (6) #6 x 5/8" OPH tapping screws
Options: May be ordered cut for cylinder (CFC) or engraved "PUSH"
Notes: For sizes or finishes not listed in this catalog, contact Hager Customer Service for availability

Available in Sizes					
Inches	3 x 12	3-1/2 x 15	4 x 16	6 x 16	8 x 16
Millimeters	76 x 305	89 x 38	102 x 406	152 x 406	203 x 406

PUSH PLATES



90R

Radius Corner - Non-Beveled Push Plate

Certification: Meets ANSI A156.6 for J304 Push Plate
Gauge: 0.125" (3.2 mm)
Materials: Aluminum, brass, bronze, stainless steel
Finishes: US3, US4, US10, US10B, US26, US26D, US28, US32, US32D
Fasteners: Six (6) #6 x 5/8" OPH tapping screws
Options: May be ordered cut for cylinder (CFC) or engraved "PUSH"
Notes: For sizes or finishes not listed in this catalog, contact Hager Customer Service for availability

Available in Sizes					
Inches	3 x 12	3-1/2 x 15	4 x 16	6 x 16	8 x 16
Millimeters	76 x 305	89 x 38	102 x 406	152 x 406	203 x 406



100T

Square Corner - Rounded Bevel Top and Bottom Push Plate

Certification: Meets ANSI A156.6 for J304 Push Plate
Gauge: 0.125" (3.2 mm)
Materials: Aluminum, brass, bronze, stainless steel
Finishes: US3, US4, US10, US10B, US26, US26D, US28, US32, US32D
Fasteners: Six (6) #6 x 5/8" OPH tapping screws
Options: May be ordered cut for cylinder (CFC) or engraved "PUSH"
Notes: For sizes or finishes not listed in this catalog, contact Hager Customer Service for availability

Available in Sizes					
Inches	3 x 12	3-1/2 x 15	4 x 16	6 x 16	8 x 16
Millimeters	76 x 305	89 x 38	102 x 406	152 x 406	203 x 406



110S

Half Circle Push Plate

Certification: Meets ANSI A156.6 for J301 Push Plate
Plate: 8" x 16" (203 mm x 406 mm)
Gauge: 0.050" (1.3 mm)
Materials: Aluminum, brass, bronze, stainless steel
Finishes: US3, US4, US10B, US26, US26D, US28, US32, US32D
Fasteners: Six (6) #6 x 5/8" OPH tapping screws
Options: May be ordered cut for cylinder (CFC) or engraved "PUSH"
Notes: For sizes or finishes not listed in this catalog, contact Hager Customer Service for availability





PUSH PLATES



120L

Pull Plate with Lip - Non-Beveled

- Certification: Meets ANSI A156.6 for J303 Plate
 Plate: 3-1/2" x 16" (89 mm x 406 mm)
 Lip Projection: 1-1/8" (29 mm)
 Gauge: 0.125" (3.2 mm)
 Materials: Aluminum, brass, bronze, stainless steel
 Finishes: US3, US4, US10, US10B, US26, US26D, US28, US32, US32D
 Fasteners: Six (6) #6 x 5/8" OPH tapping screws
 Options:
 - Other sizes available, please specify
 - May be ordered cut for cylinder (CFC) or engraved
 Notes: For sizes or finishes not listed in this catalog, contact Hager Customer Service for availability



121L

Cylinder Pull - Beveled

- Plate: 2" x 3-3/4" (51 mm x 95 mm)
 Lip Projection: 1-1/8" (29 mm)
 Cylinder Cutout: 1-1/4" (32 mm) diameter
 Gauge: 0.125" (3.2 mm)
 Materials: Aluminum, brass, bronze, stainless steel
 Finishes: US3, US4, US10, US10B, US26, US26D, US28, US32, US32D
 Fasteners: Attached by lock cylinder
 Notes:
 - 1/4"-20 x 3/8" stud installed on reverse side to eliminate twisting
 - For sizes or finishes not listed in this catalog, contact Hager Customer Service for availability



122L

Security Pull/Push Plate Set - Beveled

- Certification: Meets ANSI A156.6 for combination J304 Push Plate and J303 Flush Pull
 Push Plate: 4" x 16" (102 mm x 406 mm)
 Pull Plate: 4" x 9-1/4" (102 mm x 235 mm)
 Lip Projection: 2-1/8" (54 mm)
 Gauge: 0.125" (3.2 mm)
 Materials: Stainless steel
 Finishes: US32D
 Fasteners: Four (4) 8-32 FPHMS (Security Torx) sex nuts and bolts
 Two (2) 8-32 x 1/2" FPHMS (Security Torx)
 Notes: For sizes or finishes not listed in this catalog, contact Hager Customer Service for availability

PUSH BARS



125S **Bent Push Bar**

Certification: Meets ANSI A156.6 for J501 Push Bar
Bar Size: 3/8" x 1-1/4" (10 mm x 32 mm)
Projection: 2-1/8" (54 mm)
Base Plate: 1" x 3" (25 mm x 76 mm)
Materials: Aluminum, brass, bronze, stainless steel
Finishes: US3, US4, US10, US10B, US28, US32, US32D
Fasteners: Two (2) #8 x 3/4" FPH tapping screws and one (1) 1/4 - 20 OPHMS
Options: May be ordered with thru bolts in place of surface screws



126S **Push Bar**

Certification: Meets ANSI A156.6 for J501 Push Bar
Bar Size: 3/8" x 1-1/4" (10 mm x 32 mm)
Projection: 2-1/8" (54 mm)
Base Plate: 1" x 3" (25 mm x 76 mm)
Materials: Aluminum, brass, bronze, stainless steel
Finishes: US3, US4, US10, US10B, US28, US32, US32D
Fasteners: Four (4) #8 x 3/4" FPH tapping screws
Options: May be ordered with thru bolts in place of surface screws



127S **Push Bar**

Certification: Meets ANSI A156.6 for J501 Push Bar
Bar Size: 3/8" x 1-1/4" (10 mm x 32 mm)
Projection: 3/4" (19 mm)
Base Plate: 1-1/4" x 1-1/4" (32 mm x 32 mm)
Materials: Aluminum, brass, bronze, stainless steel
Finishes: US3, US4, US10, US10B, US28, US32, US32D
Fasteners: Two (2) 1/4-20 FPHMS
Options: May be ordered with thru bolts in place of surface screws



128P **Wide Push Bar**

Certification: Meets ANSI A156.6 for J501 Push Bar
Bar Size: 3/8" x 3" (10 mm x 76 mm)
Projection: 2-1/8" (54 mm)
Base Plate: 1-1/2" x 4-1/2" (38 mm x 114 mm)
Materials: Aluminum, brass, bronze, stainless steel
Finishes: US3, US4, US10, US10B, US26, US26D, US28, US32, US32D
Fasteners: Eight (8) #8 x 3/4" FPH tapping screws





PUSH BARS



128S **Wide Push Bar**

Certification: Meets ANSI A156.6 for J501 Push Bar
 Bar Size: 3/8" x 3" (10 mm x 76 mm)
 Projection: 2" (51 mm)
 Base Plate: 1-1/2" x 4-1/2" (38 mm x 114 mm)
 Door Thickness: 1-3/4" (45 mm) - Standard
 Materials: Aluminum, brass, bronze, stainless steel
 Finishes: US3, US4, US10, US10B, US26, US26D, US28, US32, US32D
 Fasteners: Two (2) 1/4 - 20 x 2-1/4" FPHMS with finish washers
 Notes: 128S is same as 128P, but without base plates



129P **Wide Push Bar**

Certification: Meets ANSI A156.6 for J501 Push Bar
 Bar Size: 3/8" x 3" (10 mm x 76 mm)
 Projection: 3/4" (19 mm)
 Base Plate: 1" x 3" (25 mm x 76 mm)
 Materials: Aluminum, brass, bronze, stainless steel
 Finishes: US3, US4, US10, US10B, US28, US32, US32D
 Fasteners: Two (2) 1/4-20 x 1-1/4" FPHMS
 Options:

- May be ordered with thru bolts in place of surface screws
- #14 Flat head wood screws available on special order



130S **Round Push Bar**

Certification: Meets ANSI A156.6 for J501 Push Bar
 Bar Stock: 1" (25 mm)
 Projection: 2-1/2" (64 mm)
 Door Thickness: 1-3/4" (45 mm) - Standard
 Materials: Aluminum, brass, bronze, stainless steel
 Finishes: US3, US4, US10, US10B, US28, US32, US32D
 Fasteners: Two (2) 1/4-20 x 20 x 2-1/4" FPHMS with finish washers
 Options: May be ordered with Type 5 concealed mountings at extra charge



131S **Round Push Bar**

Certification: Meets ANSI A156.6 for J501 Push Bar
 Bar Stock: 1" (25 mm)
 Projection: 2-5/8" (67 mm)
 Base Diameter: 2" (51 mm)
 Door Thickness: 1-3/4" (45 mm) - Standard
 Materials: Aluminum, brass, bronze, stainless steel
 Finishes: US3, US4, US10, US10B, US28, US32, US32D
 Fasteners: Two (2) 1/4-20 x 2-1/4" FPHMS with finish washers
 Options: May be ordered with Type 5 concealed mountings at extra charge

PUSH BARS



133S

Round Push Bar

Certification: Meets ANSI A156.6 for J501 Push Bar
 Bar Stock: 3/4" (19 mm)
 Projection: 2-1/4" (57 mm)
 Door Thickness: 1-3/4" (45 mm) - Standard
 Materials: Aluminum, brass, bronze, stainless steel
 Finishes: US3, US4, US10, US10B, US28, US32, US32D
 Fasteners: Two (2) 1/4 - 20 x 2-1/4" FPHMS with finish washers



134S

Round Push Bar

Certification: Meets ANSI A156.6 for J501 Push Bar
 Bar Stock: 3/4" (19 mm)
 Projection: 2-3/8" (60 mm)
 Base Diameter: 1-1/4" (32 mm)
 Door Thickness: 1-3/4" (45 mm) - Standard
 Materials: Aluminum, brass, bronze, stainless steel
 Finishes: US3, US4, US10, US10B, US28, US32, US32D
 Fasteners: Two (2) 1/4 - 20 x 2-1/4" FPHMS with finish washers
 Options: May be ordered with Type 5 concealed mountings at extra charge



136S

Round Push Bar

Certification: Meets ANSI A156.6 for J501 Push Bar
 Bar Stock: 1-1/4" (32 mm)
 Projection: 3" (76 mm)
 Door Thickness: 1-3/4" (45 mm) - Standard
 Materials: Aluminum, brass, bronze, stainless steel
 Finishes: US3, US4, US10, US10B, US28, US32, US32D
 Fasteners: Two (2) 5/16 - 18 x 2-1/4" FPHMS with finish washers
 Options: May be ordered with Type 5 concealed mountings at extra charge



137S

Round Push Bar

Certification: Meets ANSI A156.6 for J501 Push Bar
 Bar Stock: 1-1/4" (32 mm)
 Projection: 3-1/8" (79 mm)
 Base Diameter: 2" (51 mm)
 Door Thickness: 1-3/4" (45 mm) - Standard
 Materials: Aluminum, brass, bronze, stainless steel
 Finishes: US3, US4, US10, US10B, US28, US32, US32D
 Fasteners: Two (2) 5/16 - 18 x 2-1/4" FPHMS with finish washers
 Options: May be ordered with Type 5 concealed mountings at extra charge





PUSH & PULL BAR SETS



138P Round Push/Pull Set

Certification: Meets ANSI A156.6 for J504 Bar Sets
 Bar Stock: 1" (25 mm)
 Projection: 2-1/2" (64 mm)
 Materials: Aluminum, brass, bronze, stainless steel
 Finishes: US3, US4, US10, US10B, US28, US32, US32D
 Fasteners: Two (2) 1/4-20 Type 3 concealed cone



139P Round Push/Pull Set

Certification: Meets ANSI A156.6 for J504 Bar Sets
 Bar Stock: 3/4" (19 mm)
 Projection: 2-1/4" (60 mm)
 Materials: Aluminum, brass, bronze, stainless steel
 Finishes: US3, US4, US10, US10B, US28, US32, US32D
 Fasteners: Two (2) 1/4-20 Type 3 concealed cone



140P Round Push/Pull Set

Certification: Meets ANSI A156.6 for J504 Bar Sets
 Bar Stock: 1-1/4" (32 mm)
 Projection: 3" (76 mm)
 Materials: Aluminum, brass, bronze, stainless steel
 Finishes: US3, US4, US10, US10B, US28, US32, US32D
 Fasteners: Two (2) 5/16-18 Type 3 concealed cone



150D | 150V | 150B Round Push/Pull Set*

Certification: Meets ANSI A156.6 for J504 Bar Sets
 Bar Stock: 3/4" (19 mm)
 Projection: 2-1/4" (57 mm)
 Pull CTC: 8" (203 mm)
 Materials: Aluminum, brass, bronze, stainless steel
 Finishes: US3, US4, US10, US10B, US28, US32, US32D

*
D = Standard Fastening - One (1) 3/8-16 Type 7 spanner collar connection between push bar and pull plus two (2) 1/4-20 Type 1 connections for other ends of push bar and pull.
V = Fully Concealed Fastening - One (1) 3/8-16 Type 7 spanner collar connection between push bar and pull plus two (2) 1/4-20 Type 5 connections for ends of push bar and pull.
B = Tempered Glass Fastening - One (1) 3/8-16 Type 7 spanner collar connection between push bar and pull plus two (2) 1/4-20 Type 8 connections for ends of push bar and pull plus gaskets that separate metal parts from glass.

PUSH & PULL BAR SETS



151D | 151V | 151B

Round Push/Pull Set*

Certification: Meets ANSI A156.6 for J504 Bar Sets
 Bar Stock: 3/4" (19 mm)
 Projection: 2-1/4" (57 mm)
 Pull CTC: 10" (254 mm)
 Materials: Aluminum, brass, bronze, stainless steel
 Finishes: US3, US4, US10, US10B, US28, US32, US32D



152D | 152V | 152B

Round Push/Pull Set*

Certification: Meets ANSI A156.6 for J504 Bar Sets
 Bar Stock: 3/4" (19 mm)
 Projection: 2-1/4" (57 mm)
 Pull CTC: 12" (305 mm)
 Materials: Aluminum, brass, bronze, stainless steel
 Finishes: US3, US4, US10, US10B, US28, US32, US32D



153D | 153V | 153B

Round Push/Pull Set*

Certification: Meets ANSI A156.6 for J504 Bar Sets
 Bar Stock: 1" (25 mm)
 Projection: 2-1/2" (64 mm)
 Pull CTC: 10" (254 mm)
 Materials: Aluminum, brass, bronze, stainless steel
 Finishes: US3, US4, US10, US10B, US28, US32, US32D



154D | 154V | 154B

Round Push/Pull Set*

Certification: Meets ANSI A156.6 for J504 Bar Sets
 Bar Stock: 1" (25 mm)
 Projection: 2-1/2" (64 mm)
 Pull CTC: 12" (305 mm)
 Materials: Aluminum, brass, bronze, stainless steel
 Finishes: US3, US4, US10, US10B, US28, US32, US32D

*

D = Standard Fastening - One (1) 3/8-16 Type 7 spanner collar connection between push bar and pull plus two (2) 1/4-20 Type 1 connections for other ends of push bar and pull.

V = Fully Concealed Fastening - One (1) 3/8-16 Type 7 spanner collar connection between push bar and pull plus two (2) 1/4-20 Type 5 connections for ends of push bar and pull.

B = Tempered Glass Fastening - One (1) 3/8-16 Type 7 spanner collar connection between push bar and pull plus two (2) 1/4-20 Type 8 connections for ends of push bar and pull plus gaskets that separate metal parts from glass.





PUSH & PULL BAR SETS



155D | 155V | 155B

Round Push/Pull Set*

Certification: Meets ANSI A156.6 for J504 Bar Sets
 Bar Stock: 1" (25 mm)
 Projection: 2-1/2" (64 mm)
 Pull CTC: 18" (457 mm)
 Materials: Aluminum, brass, bronze, stainless steel
 Finishes: US3, US4, US10, US10B, US28, US32, US32D



156D | 156V | 156B

Round Push/Pull Set*

Certification: Meets ANSI A156.6 for J505 Bar Sets
 Bar Stock: 3/4" (19 mm) diameter
 Pull Bar Projection: 2-1/2" (64 mm)
 Push Bar Projection: 2-1/4" (57 mm)
 Pull CTC: 8" (203 mm)
 Offset: 2-1/2" (64 mm), 90° Standard
 Materials: Aluminum, brass, bronze, stainless steel
 Finishes: US3, US4, US10, US10B, US28, US32, US32D
 Options: For 45° offset pull, add prefix "X" (i.e., X156D) to number
 Notes: Non-reversible; specify handing



157D | 157V | 157B

Round Push/Pull Set*

Certification: Meets ANSI A156.6 for J505 Bar Sets
 Bar Stock: 3/4" (19 mm) diameter
 Pull Bar Projection: 2-1/2" (64 mm)
 Push Bar Projection: 2-1/4" (57 mm)
 Pull CTC: 10" (254 mm)
 Offset: 2-1/2" (64 mm), 90° Standard
 Materials: Aluminum, brass, bronze, stainless steel
 Finishes: US3, US4, US10, US10B, US28, US32, US32D
 Options: For 45° offset pull, add prefix "X" (i.e., X157D) to number
 Notes: Non-reversible; specify handing



158D | 158V | 158B

Round Push/Pull Set*

Certification: Meets ANSI A156.6 for J505 Bar Sets
 Bar Stock: 3/4" (19 mm) diameter
 Pull Bar Projection: 2-1/2" (64 mm)
 Push Bar Projection: 2-1/4" (57 mm)
 Pull CTC: 12" (305 mm)
 Offset: 2-1/2" (64 mm), 90° Standard
 Materials: Aluminum, brass, bronze, stainless steel
 Finishes: US3, US4, US10, US10B, US28, US32, US32D
 Options: For 45° offset pull, add prefix "X" (i.e., X158D) to number
 Notes: Non-reversible; specify handing

*

D = Standard Fastening - One (1) 3/8-16 Type 7 spanner collar connection between push bar and pull plus two (2) 5/16-18 Type 1 connections for other ends of push bar and pull.

V = Fully Concealed Fastening - One (1) 3/8-16 Type 7 spanner collar connection between push bar and pull plus two (2) 5/16-18 Type 5 connections for ends of push bar and pull.

B = Tempered Glass Fastening - One (1) 3/8-16 Type 7 spanner collar connection between push bar and pull plus two (2) 5/16-18 Type 8 connections for ends of push bar and pull plus gaskets that separate metal parts from glass.

PUSH & PULL BAR SETS



159D | 159V | 159B

Round Push/Pull Set*

Certification:	Meets ANSI A156.6 for J505 Bar Sets
Bar Stock:	1" (25 mm)
Projection:	2-1/2" (64 mm)
Pull CTC:	10" (254 mm)
Offset:	3" (76 mm), 90° Standard
Materials:	Aluminum, brass, bronze, stainless steel
Finishes:	US3, US4, US10, US10B, US28, US32, US32D
Options:	For 45° offset pull, add prefix "X" to number (i.e., X159D)
Notes:	Non-reversible; specify handing



160D | 160V | 160B

Round Push/Pull Set*

Certification:	Meets ANSI A156.6 for J505 Bar Sets
Bar Stock:	1" (25 mm)
Projection:	2-1/2" (64 mm)
Pull CTC:	12" (305 mm)
Offset:	3" (76 mm), 90° Standard
Materials:	Aluminum, brass, bronze, stainless steel
Finishes:	US3, US4, US10, US10B, US28, US32, US32D
Options:	For 45° offset pull, add prefix "X" to number (i.e., X160D)
Notes:	Non-reversible; specify handing



161D | 161V | 161B

Round Push/Pull Set*

Certification:	Meets ANSI A156.6 for J505 Bar Sets
Bar Stock:	1" (25 mm)
Projection:	2-1/2" (64 mm)
Pull CTC:	18" (457 mm)
Offset:	3" (76 mm), 90° Standard
Materials:	Aluminum, brass, bronze, stainless steel
Finishes:	US3, US4, US10, US10B, US28, US32, US32D
Options:	For 45° offset pull, add prefix "X" to number (i.e., X161D)
Notes:	Non-reversible; specify handing



164D | 164V | 164B

Round Push/Pull Set*

Certification:	Meets ANSI A156.6 for J504 Bar Sets
Bar Stock:	1-1/4" (32 mm)
Projection:	3" (76 mm)
Pull CTC:	12" (305 mm)
Materials:	Aluminum, brass, bronze, stainless steel
Finishes:	US3, US4, US10, US10B, US28, US32, US32D

*

D = Standard Fastening - One (1) 3/8-16 Type 7 spanner collar connection between push bar and pull plus two (2) 5/16-18 Type 1 connections for other ends of push bar and pull.

V = Fully Concealed Fastening - One (1) 3/8-16 Type 7 spanner collar connection between push bar and pull plus two (2) 5/16-18 Type 5 connections for ends of push bar and pull.

B = Tempered Glass Fastening - One (1) 3/8-16 Type 7 spanner collar connection between push bar and pull plus two (2) 5/16-18 Type 8 connections for ends of push bar and pull plus gaskets that separate metal parts from glass.





PUSH & PULL BAR SETS



165D | 165V | 165B

Round Push/Pull Set*

Certification: Meets ANSI A156.6 for J504 Bar Sets
 Bar Stock: 1-1/4" (32 mm)
 Projection: 3" (76 mm)
 Pull CTC: 18" (457 mm)
 Materials: Aluminum, brass, bronze, stainless steel
 Finishes: US3, US4, US10, US10B, US28, US32, US32D



167D | 167V | 167B

Round Push/Pull Set*

Certification: Meets ANSI A156.6 for J505 Bar Sets
 Bar Stock: 1-1/4" (32 mm)
 Projection: 3" (76 mm)
 Pull CTC: 18" (457 mm)
 Offset: 3-3/4" (96 mm), 90° Standard
 Materials: Aluminum, brass, bronze, stainless steel
 Finishes: US3, US4, US10, US10B, US28, US32, US32D
 Notes: Non-reversible; specify handing



170D Push/Pull Set

Certification: Meets ANSI A156.6 for J502 Bar Sets
 Bar Stock: 3/8" x 1-1/4" (10 mm x 32 mm)
 Pull Bar Projection: 2-1/2" (64 mm)
 Push Bar Projection: 3/4" (19 mm)
 Base: 1-1/4" x 1-1/4" (32 x 32 mm)
 Horizontal Spacing CTC: 8" (203 mm)
 Materials: Aluminum, brass, bronze, stainless steel
 Finishes: US3, US4, US10, US10B, US28, US32, US32D
 Notes:

- Bars are mounted back to back with 1/4"-20 thru bolt type 4 mounting
- Non-reversible; specify handing

*

D = Standard Fastening - One (1) 3/8-16 Type 7 spanner collar connection between push bar and pull plus two (2) 5/16-18 Type 1 connections for other ends of push bar and pull.

V = Fully Concealed Fastening - One (1) 3/8-16 Type 7 spanner collar connection between push bar and pull plus two (2) 5/16-18 Type 5 connections for ends of push bar and pull.

B = Tempered Glass Fastening - One (1) 3/8-16 Type 7 spanner collar connection between push bar and pull plus two (2) 5/16-18 Type 8 connections for ends of push bar and pull plus gaskets that separate metal parts from glass.

All push bar units are made to order. Specify CTC lengths, fastening method unless standard, and type of door (WO, HM, AL, etc.).



DOOR EDGINGS & CORNER GUARDS

180H | 180K | 180M | 180P | 180Q

Mortise Door Edging

Certification: Meets ANSI A156.6 Door Edging Type J201 through J212

Standard Length: 36" – 42" (914 mm – 1067 mm)

Materials: Aluminum, stainless steel

Gauge: 0.045" - 0.050" (1.1 mm - 1.3 mm)

Finishes: US28, US32D

Fasteners: #6 x 3/4" FPH tapping screws

Options:

- Other lengths by quotation
- Hinge cutout available
- Latch cutout available
- UL rated edging available

Order:

- Provide actual rather than typical door thickness
- Provide item #, size and finish (i.e., 180H - 40"-32D)

Notes:

- Cutout will hand edging; specify handing information
- Standard edge guards are made for 1-3/4" +0, -1/32" thick doors

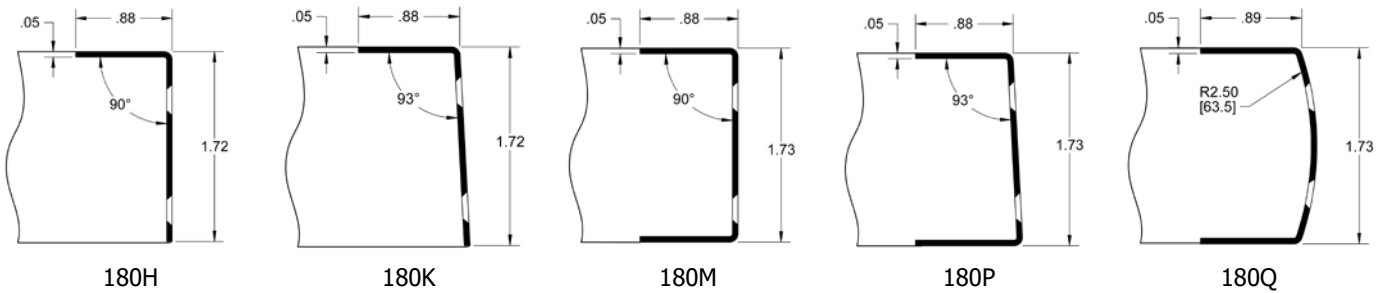

181H | 181K | 181M | 181P | 181Q

Overlap Door Edging

Certification: Meets ANSI A156.6 Door Edging Type J201 through J212

Standard Length: 36" – 42" (914 mm – 1067 mm)

Materials: Aluminum, stainless steel

Gauge: 0.045" - 0.050" (1.1 mm - 1.3 mm)

Finishes: US28, US32D

Fasteners: #6 x 3/4" FPH tapping screws

Options:

- Other lengths by quotation
- Hinge cutout available
- Latch cutout available
- UL rated edging available

Order:

- Provide actual rather than typical door thickness
- Provide item #, size and finish (i.e., 181H - 40"-32D)

Notes:

- Cutout will hand edging; specify handing information
- Standard edge guards are made for 1-3/4" +0, -1/32" thick doors

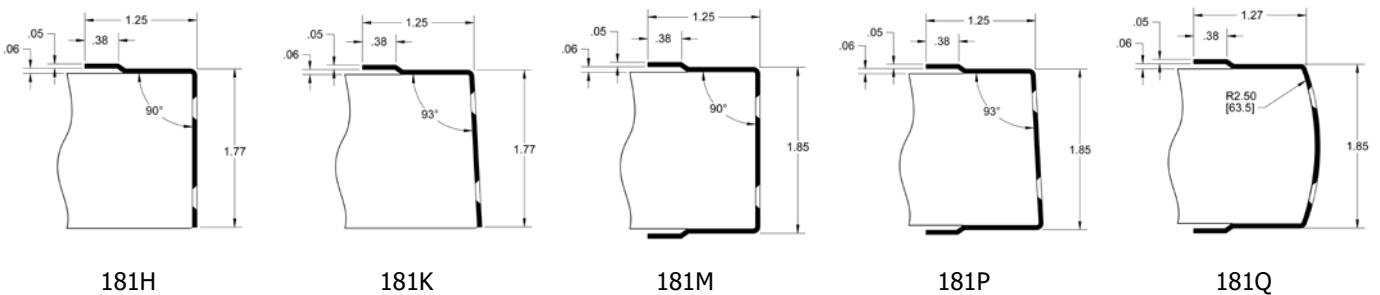



DOOR EDGINGS & CORNER GUARDS

182H | 182K | 182M | 182P | 182Q

Non-Mortise Door Edging

- Certification: Meets ANSI A156.6 Door Edging Type J201 through J212
- Standard Length: 36" – 42" (914 mm – 1067 mm)
- Materials: Aluminum, stainless steel
- Gauge: 0.045" - 0.050" (1.1 mm - 1.3 mm)
- Finishes: US28, US32D
- Fasteners: #6 x 3/4" FPH tapping screws
- Options:
- Other lengths by quotation
 - Hinge cutout available
 - Latch cutout available
 - UL rated edging available
- Order:
- Provide actual rather than typical door thickness
 - Provide item #, size and finish (i.e., 182H - 40"-32D)
- Notes:
- Cutout will hand edging; specify handing information
 - Standard edge guards are made for 1-3/4" +0, -1/32" thick doors

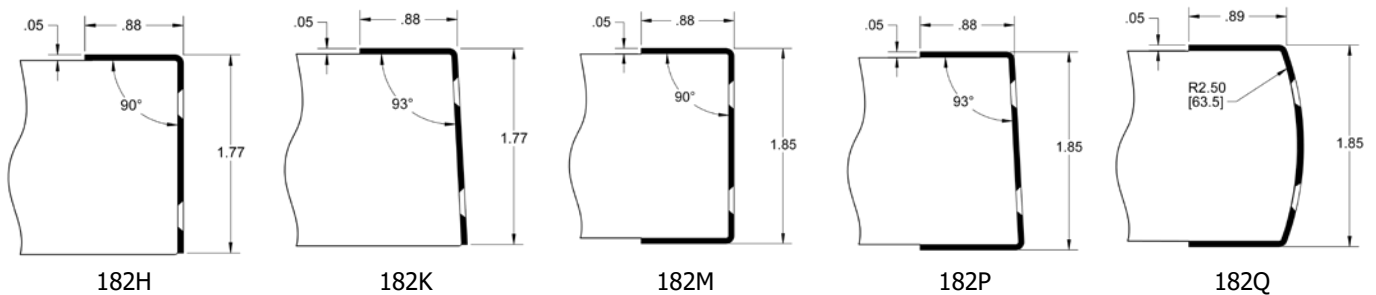

185G

Corner Guard

- Certification: Meets ANSI A156.6 for J210
- Size: 3" x 3" x 40" (76 mm x 76 mm x 1016 mm)
- Gauge: 0.050" (1.3 mm)
- Materials: Aluminum, stainless steel
- Finishes: US28, US32D
- Fasteners: #6 x 3/4" FPHSMS self drilling screws
- Options: Mounting with double-stick tape instead of screws
- Notes:
- 90° bend standard
 - Other lengths by quotation

DOOR PROTECTION PLATES



Door Protection Plates

The metal door protection plates below meet ANSI A156.6 for J101 Metal Armor Plate, J102 Metal Kickplate, and J103 Metal Mop Plate. The plastic door protection plates below meet ANSI A156.6 for J105 Plastic Armor Plate, J106 Plastic Kickplate, and J107 Plastic Mop Plate. Options for all plates include countersunk holes, UL armor plate stamped, self-adhesive tape, spanner head screws, torx head screws, round corners, wrap around side and bottom return, and 0.125" (3.2 mm) material. All plates below are supplied standard with #6 x 5/8" truss head screws (unless specified otherwise). They are available in mop plate, kick plate, stretcher plate, and armor plate sizes.

- Mop Plate:** Protects the bottom of the pull side of doors subject to cleaning and mopping procedures.
Kick Plate: Protects the bottom of the push side of doors subject to scuffing from foot traffic.
Stretcher Plate: Protects doors in specific areas where constant contact is made by stretchers, service carts, or other equipment.
Armor Plate: Protects lower half of doors from abuse by carts, trucks, and rough usage.

NFPA 80 STANDARD 6.4.5.1/6.4.5.2 /6.4.5.3 Protection Plates

- Factory installed protection plates shall be installed in accordance with the listing of the door.
- Field installed protection plate shall be labeled and installed in accordance with their listing.
- Labeling is not required where the top of the protection plate is not more than 16" (406 mm) above the bottom of the door.

190S

Thickness: 0.050" (1.3 mm)
 U.S. Gauge: 18
 Materials: Aluminum, brass, bronze, stainless steel
 Finishes: US3, US4, US10, US10B, US28, US32, US32D
 Bevel: 4 edges
 Options: UL Listed for US32 and US32D*

198S

Thickness: 0.038" (0.8 mm)
 U.S. Gauge: 20
 Materials: Stainless steel
 Finishes: US32D
 Options: UL Listed*

199B

Thickness: 0.038" (0.8 mm)
 U.S. Gauge: 20
 Materials: Aluminum
 Finishes: Bright gold anodized
 Fasteners: #6 x 5/8" TPH Tapping Screws

204S

Thickness: 0.125" (3.2 mm)
 Materials: Clear plastic
 Bevel: 4 edges

214S

Thickness: 0.125" (3.2 mm)
 Materials: Plastic laminate
 Bevel: 4 edges
 Colors: Black, Brown, Grey
 Notes: Other colors are available and will be subject to minimum order quantities; priced on application

220S

Thickness: 0.062" (1.6 mm)
 U.S. Gauge: 16
 Materials: Aluminum, brass, bronze, stainless steel
 Finishes: US3, US4, US10, US10B, US28, US32, US32D, (Diamond tread available in .063" polished aluminum only)
 Bevel: 4 edges

225S

Thickness: 0.060" (1.9 mm)
 Materials: Kydex®
 Colors: CBO - Calcutta Black, KGO - Beige, KHO - Chocolate
 Notes: Other colors are available and will be subject to minimum order quantities; priced on application
 Options: UL Listed*

*Must specify UL stamp. UL labeling not required when top of plate is less than 16" above the bottom of the door. Screw fasteners only.





WALL STOPS & HOLDERS



230W **Convex Wall Stop**

Certification: Meets ANSI A156.16 for L02101
 Diameter: 2-15/32" (63 mm)
 Projection: 1-3/32" (28 mm)
 Materials: Cast brass, bronze with grey rubber bumper
 Finishes: US3, US4, US10, US10B, US15, US15A, US19, US26, US26D
 Fasteners: One (1) #10 x 1-1/2" PPHWS with plastic and toggle anchor.
 Notes:

- Concealed tamper proof mounting
- Easy installation by inserting screwdriver through small hole in bumper
- Specify 230T for machine screw and toggle nut screwpack (10 pk)



232W **Convex Wall Stop**

Certification: Meets ANSI A156.16 for L02101
 Diameter: 2-7/16" (62 mm)
 Projection: 1" (25 mm)
 Materials: Wrought brass, bronze, stainless steel with grey rubber bumper
 Finishes: US3, US4, US5, US9, US10, US10B, US15, US15A, US19, US26, US26D, US32, US32D
 Fasteners: One (1) #10 x 1-1/2" PPHWS with plastic and toggle anchor
 Notes:

- Concealed tamper proof mounting
- Easy installation by inserting screwdriver through small hole in bumper
- Specify 230T for machine screw and toggle nut screwpack (10 pk)



234W **Concave Wall Stop**

Certification: Meets ANSI A156.16 for L02251
 Diameter: 2-15/32" (63 mm)
 Projection: 1-3/32" (28 mm)
 Materials: Cast brass, bronze with grey rubber bumper
 Finishes: US3, US4, US10, US10B, US15, US15A, US19, US26, US26D
 Fasteners: One (1) #10 x 1-1/2" PPHWS w/ plastic and toggle anchor
 Notes:

- Easy installation by inserting screwdriver through small hole in rubber bumper
- Concealed tamper proof mounting
- Concave rubber bumper prevents damage to locksets with projecting buttons
- Specify 230T for machine screw and toggle nut screwpack (10 pk)



236W **Concave Wall Stop**

Certification: Meets ANSI A156.16 for L02251
 Diameter: 2-7/16" (75 mm)
 Projection: 1" (25 mm)
 Materials: Wrought brass, bronze, stainless steel with grey rubber bumper
 Finishes: US3, US4, US5, US9, US10, US10B, US15, US15A, US19, US26, US26D, US32, US32D
 Fasteners: One (1) #10 x 1-1/2" PPHWS w/ plastic and toggle anchor
 Notes:

- Easy installation by inserting screwdriver through small hole in rubber bumper
- Concealed tamper proof mounting
- Concave rubber bumper prevents damage to locksets with projecting buttons
- Specify 230T for machine screw and toggle nut screwpack (10 Pk)

WALL STOPS & HOLDERS



250W

Convex Wall Stop

Diameter: 1" (25 mm)
 Projection: 9/16" (14 mm)
 Materials: Cast brass
 Finishes: US3, US4, US10, US10B, US15, US15A, US19, US26, US26D
 Fasteners: One (1) #6 x 3/4" screw with plastic anchor and one (1) 0.052 diameter nail
 Notes:

- Concealed mounting screw prevents vandalism
- For use on drywall
- Compact design



251W

Concave Wall Stop

Diameter: 1-7/8" (48 mm)
 Projection: 25/32" (20 mm)
 Materials: Adhesive backed rubber bumper
 Finish: Grey only
 Notes:

- Concave bumper prevents damage to locksets with projecting buttons
- For areas where concealed mounting is not required
- Adhesive backing for use on clean smooth flat surfaces only



254S

Wall Stop & Holder

Certification: Meets ANSI A156.16 for L01341
 Base Diameter: 2-11/32" (60 mm)
 Base Projection: 3-1/2" (89 mm)
 Engaged Projection: 5-19/32" (142 mm)
 Keeper: 1" x 2" (25 mm x 51 mm)
 Materials: Cast brass with black rubber bumper
 Finishes: US3, US4, US10, US10B, US15, US26, US26D
 Fasteners: Five (5) #10 x 1" FPHWS, and three (3) plastic anchors
 Notes:

- For use on drywall
- Manual holder ideal for interior and exterior applications
- Unit functions as a stop, but can serve as a "Hold Open" when hook is manually engaged
- Ideal for use with locksets with a projection of 3-5/16" (84 mm) or less



254W

Wall Stop & Holder

Certification: Meets ANSI A156.16 for L01351
 Base Diameter: 2-11/32" (60 mm)
 Base Projection: 3-1/2" (89 mm)
 Engaged Projection: 5-19/32" (142 mm)
 Keeper: 1" x 2" (25 mm x 51 mm)
 Materials: Cast brass with black rubber bumper
 Finishes: US3, US4, US10, US10B, US15, US26, US26D
 Fasteners: Three (3) #10 x 1" FPH tapping screw, one (1) plastic anchor, one (1) 5/16-18 x 2-1/2" threaded stud, and one (1) 5/16-18 lead anchor
 Notes:

- For use on concrete walls
- Manual holder ideal for interior and exterior applications
- Unit functions as a stop, but can serve as a "Hold Open" when hook is manually engaged
- Ideal for use with locksets with a projection of 3-5/16" (84 mm) or less





WALL STOPS & HOLDERS



255S

Wall Stop

- Certification: Meets ANSI A156.16 for L02011
 Base Diameter: 2-11/32" (60 mm)
 Projection: 3-11/16" (94 mm)
 Materials: Cast brass with black rubber bumper
 Finishes: US3, US4, US10, US10B, US15, US26, US26D
 Fasteners: Three (3) #10 x 1" OPHWS and three (3) plastic anchors
 Notes:
 - For use on drywall
 - Ideal for interior and exterior applications
 - Heavy duty - for use in high traffic areas
 - Ideal for use with locksets with a projection of 3" (76 mm) or less



255W

Wall Stop

- Certification: Meets ANSI A156.16 for L02021
 Base Diameter: 2-11/32" (60 mm)
 Projection: 3-11/16" (94 mm)
 Materials: Cast brass with black rubber bumper
 Finishes: US3, US4, US10, US10B, US15, US26, US26D
 Fasteners: One (1) #10 x 1" OPHWS, one (1) plastic anchor, one (1) 5/16-18 lead anchor, one (1) 5/16-18 x 2-1/2" threaded stud, one (1) 5/16-18 x 2-1/2" combo threaded stud
 Notes:
 - For use on concrete walls
 - Ideal for interior and exterior applications
 - Heavy duty - for use in high traffic areas
 - Ideal for use with locksets with a projection of 3" (76 mm) or less



256S

Manual Wall Stop & Holder

- Certification: Meets ANSI A156.16 for L01341
 Base Diameter: 2-1/4" (57 mm)
 Base Projection: 3-3/4" (95 mm)
 Engaged Projection: 5-11/16" (145 mm)
 Keeper: 25/32" x 1-1/2" (20 mm x 38 mm)
 Materials: Cast brass with black rubber bumper
 Finishes: US3, US10, US10B, US26D
 Fasteners: Three (3) #10 x 1" OPHWS and three (3) plastic anchors
 Notes:
 - For use on drywall
 - Ideal for interior and exterior applications
 - Heavy duty - for use in high traffic areas
 - Unit functions as a stop, but can serve as a "Hold Open" when hook is manually engaged
 - Ideal for use with locksets with a projection of 3" (76 mm) or less



WALL STOPS & HOLDERS



256W

Manual Wall Stop & Holder

Certification: Meets ANSI A156.16 for L01351
Base Diameter: 2-1/4" (57 mm)
Base Projection: 3-3/4" (95 mm)
Engaged Projection: 5-11/16" (145 mm)
Keeper: 25/32" x 1-1/2" (20 mm x 38 mm)
Materials: Cast brass with black rubber bumper
Finishes: US3, US10, US10B, US15, US26, US26D
Fasteners: One (1) #10 x 1" OPHWS, one (1) plastic anchor, one (1) 5/16-18 lead anchor, one (1) 5/16-18 x 2-1/2" threaded stud, and one (1) 5/16-18 x 2-1/2" combo threaded stud

Notes:

- For use on concrete walls
- Ideal for interior and exterior applications
- Heavy duty - for use in high traffic areas
- Unit functions as a stop, but can serve as a "Hold Open" when hook is manually engaged
- Ideal for use with locksets with a projection of 3" (76 mm) or less



260W

Angled Wall Stop

Certification: Meets ANSI A156.16 for L02201
Base: 2-3/16" x 2-15/16" (56 mm x 75 mm)
Projection: 3-21/32" (93 mm)
Materials: Cast brass with black rubber bumper
Finishes: US26D
Fasteners: Three (3) #14 x 1-1/2" FPHWS, three (3) 1/4-20 x 3/4" FPHMS, three (3) plastic anchors, and three (3) 1/4-20 lead anchors

Notes:

- For use with drywall or concrete walls
- Sloping design resists vandalism
- Ideal for use with locksets with a projection of 3" (76 mm) or less



324W

Light Duty Wall Bumper

Certification: Meets ANSI A156.16 for L02031
Base Diameter: 1-1/4" (32 mm)
Projection: 3-1/4" (83 mm)
Tip Diameter: 5/8" (16 mm)
Materials: Cast brass, bronze with white rubber tip
Finishes: US3, US4, US5, US10, US10B, US15, US15A, US19, US26, US26D
Fastener: #10 x 7/8" wood thread

Notes:

- Replaceable rubber tip available
- Hex shape near the tip allows usage of a wrench for easier installation





WALL STOPS & HOLDERS



326W

Automatic Wall Stop & Holder

Certification: Meets ANSI A156.16 for L01293
 Holder Base: 2-13/32" x 2-25/32" (61 mm x 71 mm)
 Holder Projection: 2-5/16" (59 mm)
 Engaged Projection: 3-5/8" (92 mm)
 Strike Base: 1" x 2-1/16" (25 mm x 52 mm)
 Strike Projection: 2" (51 mm)
 Keeper: 1" x 2" (25 mm x 51 mm)
 Materials: Cast brass
 Finishes: US3, US10, US10B, US26, US26D
 Fasteners: Five (5) #10 x 1" OPHWS, three (3) 10-24 x 1-1/4" FPHMS, and three (3) plastic anchors

Notes:

- For use with wood or metal doors
- Holder is mounted on the door
- Roller is spring loaded to seat on strike - heavy duty rubber pad dampens sound and shock
- Ideal for use with locksets with a projection of 3" (76 mm) or less



327W

Automatic Wall Stop & Holder

Certification: Meets ANSI A156.16 for L11291
 Holder Base: 3-1/16" x 3-1/2" (78 mm x 89 mm)
 Holder Projection: 1-15/16" (49 mm)
 Engaged Projection: 3-1/2" (89 mm)
 Strike Diameter: 2-3/8" (60 mm)
 Strike Projection: 3-1/16" (78 mm)
 Materials: Cast brass
 Finishes: US3, US4, US10, US10B, US26, US26D
 Fasteners: Three (3) #14 x 1-1/2" FPHWS, three (3) 1/4-20 x 3/4" FPHMS, four (4) 12-24 x 1" TPHMS, four (4) #12 x 1" TPHWS, and three (3) 1/4-20 lead anchors

Notes:

- For use with wood or metal doors
- For use with drywall or concrete walls
- Roller is spring loaded to seat on strike - heavy duty rubber pad dampens sound and shock
- Strike is adjustable 45° left or right
- Holder has vertical adjustment once mounted on the door
- Ideal for use with locksets with a projection of 3" (76 mm) or less
- For doors up to 500 lbs



ROLLER STOPS



271W

Roller Bumper

Certification:

Base Diameter:

Projection:

Materials:

Finishes:

Fasteners:

Notes:

Meets ANSI A156.16 for L02193

2" (51 mm)

4-1/2" (114 mm)

Cast brass with grey rubber roller

US3, US10, US10B, US26, US26D

Three (3) #10 x 1" FPHWS and three (3) plastic anchors

- For use when two doors swing into each other at right angles (back to back)
- Prevents damage to the door and door hardware

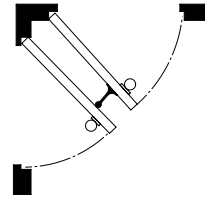

272W

Roller Bumper

Certification:

Base Diameter:

Projection:

Materials:

Finishes:

Fasteners:

Notes:

Meets ANSI A156.16 for L02193

2" (51 mm)

6-1/4" (159 mm)

Cast brass with grey rubber roller

US3, US10, US10B, US26, US26D

Three (3) #10 x 1" FPHWS, and three (3) plastic anchors

- For use when two doors swing into each other at right angles (back to back)
- Prevents damage to the door and door hardware

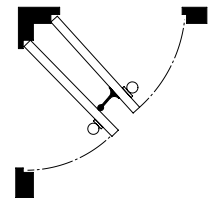

273W

Curved Roller Bumper

Certification:

Projection:

Materials:

Finishes:

Fasteners:

Notes:

Meets ANSI A156.16 for L12213

2-21/32" (67 mm)

Cast brass with grey rubber roller

US3, US4, US10, US10B, US26, US26D

Three (3) #10 x 1" FPHWS and three (3) plastic anchors

- Used when two doors swing into each other at odd angles
- Prevents damage to the door and door hardware

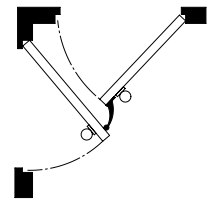



FLOOR STOPS & HOLDERS



241F | BL241F

Dome Stop - Low

Certification: Meets ANSI A156.16 for L02142
 Base Diameter: 1-11/16" (43 mm)
 Base Thickness: 1/8" (3.2 mm)
 Overall Height: 1" (25 mm)
 Materials: Cast brass with grey rubber bumper
 Finishes: US3, US4, US5, US9, US10, US10B, US15, US15A, US19, US26, US26D
 Fasteners: One (1) #14 x 1-1/2" FPHWS, one (1) 1/4-20 x 3/4" FPHMS, one (1) 1/4-20 lead anchor, and one (1) plastic anchor

Notes:

- To be used independently or in conjunction with 246B
- For use when no threshold is used (door not undercut)
- For use with wood or concrete floors
- BL241F is 241F case quantity 50



242F

Dome Stop - Universal

Certification: Meets ANSI A156.16 for L02162
 Base Diameter: 1-11/16" (43 mm)
 Base Thickness: 7/32" (5.5 mm)
 Overall Height: 1-5/8 (41 mm)
 Materials: Brass with grey rubber bumper
 Finishes: US3, US4, US10B, US15, US26, US26D
 Fasteners: One (1) #14 x 1-1/2" FPHWS, one (1) 1/4-20 x 3/4" FPHMS, one (1) 1/4-20 lead anchor, and one (1) plastic anchor

Notes: For use with wood or concrete floors



243F | BL243F

Dome Stop - High

Certification: Meets ANSI A156.16 for L02162
 Base Diameter: 1-11/16" (43 mm)
 Base Thickness: 7/16" (11 mm)
 Overall Height: 1-9/32" (33 mm)
 Materials: Cast brass with grey rubber bumper
 Finishes: US3, US4, US5, US9, US10, US10B, US15, US15A, US19, US26, US26D
 Fasteners: One (1) #14 x 1-1/2" FPHWS, one (1) 1/4-20 x 1-1/4" FPHMS, one (1) 1/4-20 lead anchor, and one (1) plastic anchor

Notes:

- For use with thresholds or undercut doors
- For use with wood or concrete floors
- BL243F is 243F case quantity 50



244F

Cast Floor Stop

Certification: Meets ANSI A156.16 for L02141
 Base: 1-3/4" x 4" (45 mm x 102 mm)
 Base Thickness: 5/32" (4 mm)
 Overall Height: 1" (25 mm)
 Materials: Cast brass with grey rubber bumper
 Finishes: US3, US4, US10, US10B, US26, US26D
 Fasteners: Two (2) #14 x 1-1/2" FPHWS, two (2) 1/4-20 x 3/4" FPHMS, two (2) 1/4-20 lead anchor, and two (2) plastic anchor

Notes:

- Heavy duty - for use in high traffic areas
- For use when no thresholds are used (door not undercut)
- For use with wood or concrete floors



FLOOR STOPS & HOLDERS



245F

Cast Floor Stop

Certification: Meets ANSI A156.16 for L02161
 Base: 1-3/4" x 4" (45 mm x 102 mm)
 Base Thickness: 1/2" (13 mm)
 Overall Height: 1-5/16" (33 mm)
 Materials: Cast brass with grey rubber bumper
 Finishes: US3, US4, US10, US10B, US26, US26D
 Fasteners: Two (2) #14 x 1-1/2" FPHWS, two (2) 1/4-20 x 1-1/4" FPHMS, two (2) 1/4-20 lead anchor, and two (2) plastic anchor
 Notes:

- Heavy duty - for use in high traffic areas
- For use with thresholds and undercut doors
- For use on wood or concrete floors



246B

Dome Stop Riser Plate

Diameter: 1-3/4" (45 mm)
 Thickness: 3/8" (10 mm)
 Fasteners: One (1) 1/4-20 x 1" FPHMS
 Materials: Cast brass
 Finishes: US3, US4, US10, US10B, US15, US15A, US19, US26, US26D
 Notes: For use with 241F on undercut doors, doors with thresholds, and carpeted flooring



248F

Modern Style Universal Stop

Base Diameter: 1-7/16" (37 mm)
 Height: 1-1/2" (38 mm)
 Materials: Brass with black rubber bumper
 Finishes: US26, US26D
 Fasteners: One (1) #12 x 1-1/4" FPHWS, one (1) plastic anchor, one (1) 1/4-20 x 1" FPHMS, and one (1) 1/4-20 lead anchor



248G

Modern Style Universal Stop

Base Diameter: 1-7/16" (37 mm)
 Height: 1-1/2" (38 mm)
 Materials: Brass with grey rubber bumper
 Finishes: US26D
 Fasteners: One (1) #12 x 1-1/4" FPHWS with plastic anchor and one (1) 1/4-20 x 1" FPHMS with lead anchor



249F

L-Shaped Floor Stop

Base: 1" x 2-1/2" x 7/32" thick (25 mm x 64 mm x 6 mm)
 Base Thickness: 1/4" (6 mm)
 Overall Height: 2-5/8" (67 mm)
 Stop face: Resilient black rubber
 Materials: Steel
 Fasteners: Two (2) #14 x 1-1/2" FPHWS and two (2) plastic anchors
 Notes: 1-1/2" (38 mm) max door to floor clearance





FLOOR STOPS & HOLDERS



252F

Floor Stop

- Certification: Meets ANSI A156.16 for L02131
 Base: 1-9/16" x 2-1/2" (40 mm x 64 mm)
 Overall Height: 2-11/16" (68 mm)
 Materials: Cast brass with black rubber bumper
 Finishes: US3, US10, US10B, US15, US15A, US19, US26, US26D
 Fasteners: One (1) #14 x 1-1/2" FPHWS, one (1) 1/4-20 x 3/4" FPHMS, one (1) 5/16-18 lead anchor, one (1) 1/4-20 lead anchor, one (1) plastic anchor, one (1) 5/16-18 x 2-1/2" threaded stud, and one (1) 5/16-18 x 2-1/2" combo threaded stud
- Notes:
- Heavy duty - for use in high traffic areas
 - For use on wood or concrete floors
 - 2" (51 mm) max door to floor clearance



257F

Floor Stop

- Certification: Meets ANSI A156.16 for L02131
 Base: 1-9/16" x 2-15/32" (40 mm x 63 mm)
 Overall Height: 2" (51 mm)
 Materials: Cast brass with black rubber bumper
 Finishes: US3, US10, US10B, US15, US15A, US19, US26, US26D
 Fasteners: One (1) #14 x 1-1/2" FPHWS, one (1) 1/4-20 x 3/4" FPHMS, one (1) 5/16-18 lead anchor, one (1) 1/4-20 lead anchors, one (1) plastic anchor, one (1) 5/16-18 x 2-1/2" threaded stud, and one (1) 5/16-18 x 2-1/2" combo threaded stud
- Notes:
- 1-3/8" (35 mm) max door to floor clearance
 - Heavy duty - for use in high traffic areas
 - For use on wood or concrete floors



258F

Floor Stop and Holder

- Certification: Meets ANSI A156.16 for L01371
 Base: 1-9/16" x 2-15/32" (40 mm x 63 mm)
 Height: 3" (76 mm)
 Keeper: 1" x 2" (25 mm x 51 mm)
 Materials: Cast brass with black rubber bumper
 Finishes: US3, US10, US10B, US15, US26, US26D
 Fasteners: Two (2) #10 x 1" FPHWS, one (1) 1/4-20 x 3/4" FPHMS, one (1) 5/16-18 lead anchor, one (1) 1/4-20 lead anchors, and one (1) 5/16-18 x 2-1/2" threaded stud
- Notes:
- 1-3/8" (35 mm) max door to floor clearance
 - Heavy duty - for use in high traffic areas
 - For use on concrete floors
 - Manual holder ideal for interior and exterior applications
 - Unit functions as a stop, but can serve as a "Hold Open" when hook is manually engaged



FLOOR STOPS & HOLDERS



259F

Tri Base Floor Stop

- Certification: Meets ANSI A156.16 for L02121
 Base: 2-1/2" wide x 1-9/16" deep (64 mm x 40 mm)
 Overall Height: 1-11/16" (43 mm)
 Material: Cast brass with grey rubber bumper
 Finishes: US3, US4, US10, US10B, US26, US26D
 Fasteners: Three (3) #10 x 1-1/4" FPHWS, three (3) plastic anchors, three (3) 10-32 x 3/4" FPHMS, and three (3) 10-32 lead anchor
- Notes:
- 1/2" (13 mm) max door to floor clearance
 - Heavy duty - for use in high traffic areas
 - For use on wood or concrete floors



259H

Tri Base Floor Stop - Tall

- Certification: Meets ANSI A156.16 for L02121
 Base: 2-1/2" wide x 1-9/16" deep (64 mm x 40 mm)
 Overall Height: 2-1/4" (57 mm)
 Materials: Cast brass with grey rubber bumper
 Finishes: US3, US4, US10, US10B, US26, US26D
 Fasteners: Three (3) #10 x 1-1/4" FPHWS, three (3) plastic anchor, three (3) 10-32 x 3/4" FPHMS, and three (3) 10-32 lead anchors
- Notes:
- 1" (25 mm) max door to floor clearance
 - Heavy duty - for use in high traffic areas
 - For use on wood or concrete floors



267F

Cast Floor Stop

- Certification: Meets ANSI A156.16 for L02131
 Base Diameter: 2-1/4" (57 mm)
 Overall Height: 3-1/8" (80 mm)
 Materials: Cast brass with black rubber bumper
 Finishes: US3, US10, US10B, US15, US15A, US19, US26, US26D
 Fasteners: One (1) #10 x 1" OPHWS, one (1) plastic anchor, one (1) 5/16-18 lead anchor, one (1) 5/16-18 x 2-1/2" threaded stud, and one (1) 5/16-18 x 2-1/2" combo threaded stud
- Notes:
- 2-3/8" (60 mm) max door to floor clearance
 - Heavy duty - for use in high traffic areas
 - For use on concrete floors



267S

Cast Floor Stop

- Certification: Meets ANSI A156.16 for L02121
 Base Diameter: 2-1/4" (57 mm)
 Overall Height: 3-1/8" (80 mm)
 Materials: Cast brass with black rubber bumper
 Finishes: US3, US10, US10B, US15, US15A, US19, US26, US26D
 Fasteners: Three (3) #10 x 1" OPHWS and three (3) plastic anchors
- Notes:
- 2-3/8" (60 mm) max door to floor clearance
 - Heavy duty - for use in high traffic areas
 - For use on wood floors





FLOOR STOPS & HOLDERS



268F

Cast Floor Stop and Holder

- Certification: Meets ANSI A156.16 for L01371
 Base Diameter: 2-1/4" (57 mm)
 Height: 3-19/32" (91 mm)
 Keeper: 25/32" x 1-1/2" (20 mm x 38 mm)
 Materials: Cast brass with black rubber bumper
 Finishes: US3, US10, US10B, US15, US15A, US19, US26, US26D
 Fasteners: Three (3) #10 x 1" OPHWS, one (1) plastic anchor, one (1) 5/16-18 lead anchor, and one (1) 5/16-18 x 2-1/2" threaded stud
- Notes:
- 2-1/2" (64 mm) max door to floor clearance
 - Heavy duty - for use in high traffic areas
 - For use on concrete floors
 - Manual holder ideal for interior and exterior applications
 - Unit functions as a stop, but can serve as a "Hold Open" when hook is manually engaged



268S

Cast Floor Stop and Holder

- Certification: Meets ANSI A156.16 for L01361
 Base Diameter: 2-1/4" (57 mm)
 Height: 3-19/32" (91 mm)
 Keeper: 25/32" x 1-1/2" (20 mm x 38 mm)
 Materials: Cast brass with black rubber bumper
 Finishes: US3, US10, US10B, US15, US15A, US19, US26, US26D
 Fasteners: Five (5) #10 x 1" OPHWS and three (3) plastic anchors
- Notes:
- 2-1/2" (64 mm) max door to floor clearance
 - Heavy duty - for use in high traffic areas
 - For use on wood floors
 - Manual holder ideal for interior and exterior applications
 - Unit functions as a stop, but can serve as a "Hold Open" when hook is manually engaged



269F

Heavy Duty Floor Stop

- Certification: Exceeds the criteria set forth for a 300-pound impact test (Report #91-04-01646)
 Bumper Diameter: 2" (51 mm)
 Bumper Height: 1-1/2" (38 mm)
 Steel Bolt: 5/8 - 11 x 2-1/2" thread
 Materials: Black rubber (fire-resistant)
- Notes:
- Designed for high vandalism areas
 - Ideal for prisons where floor stops are required
 - Grouted in concrete to eliminate exposed screws

FLOOR STOPS & HOLDERS



269T Heavy Duty Floor Stop

Certification:	Exceeds the criteria set forth for a 300-pound impact test (Report #91-04-01646)
Bumper Diameter:	2" (51 mm)
Bumper Height:	3-1/2" (89 mm)
Steel Bolt:	5/8 – 11 x 2-1/2" thread
Materials:	Black rubber (fire-resistant)
Notes:	<ul style="list-style-type: none"> • Designed for high vandalism areas • Ideal for prisons where floor stops are required • Grouted in concrete to eliminate exposed screws



326F Automatic Floor Stop and Holder

Certification:	Meets ANSI A156.16 for L01301
Holder Projection:	1-15/16" (49 mm)
Holder Base:	3-1/16" x 3-1/2" (78 mm x 89 mm)
Floor Strike:	2" x 4-3/32" (51 mm x 104 mm)
Strike Height:	1-1/4" (32 mm)
Max Door to Floor Clearance:	1/2" (13 mm) or less
Materials:	Cast brass
Finishes:	US3, US10, US10B, US26, US26D
Fasteners:	Three (3) #14 x 1-1/2" FPHWS, three (3) 1/4-20 x 3/4" FPHMS, three (3) 1/4-20 lead anchors, four (4) 12-24 x 1" TPHMS, and four (4) #12 x 1" TPHWS
Notes:	<ul style="list-style-type: none"> • For use on wood or metal doors and wood or concrete floors • Ideal for heavy traffic situations that require frequent hold open • Firm pull releases holding mechanism • Holder has vertical adjustment once mounted on the door



327F Automatic Floor Stop and Holder

Certification:	Meets ANSI A156.16 for L01301
Holder Projection:	1-15/16" (49 mm)
Holder Base:	3-1/16" x 3-1/2" (78 mm x 89 mm)
Floor Strike:	2-3/16" x 4-1/8" (56 mm x 105 mm)
Strike Height:	1-3/4" (44 mm)
Max Door to Floor Clearance:	9/16" to 1-1/16" (14 mm to 27 mm)
Materials:	Cast brass
Finishes:	US3, US10, US10B, US26, US26D
Fasteners:	Three (3) #14 x 1-1/2" FPHWS, three (3) 1/4-20 x 3/4" FPHMS, three (3) 1/4-20 lead anchors, four (4) 12-24 x 1" TPHMS, and four (4) #12 x 1" TPHWS
Notes:	<ul style="list-style-type: none"> • For use on wood or metal doors and wood or concrete floors • Ideal for heavy traffic situations that require frequent hold open • Firm pull releases holding mechanism • Holder has vertical adjustment once mounted on the door



FLOOR STOPS & HOLDERS



328F

Automatic Floor Stop and Holder

Certification: Meets ANSI A156.16 for L01301
 Holder Projection: 1-15/16" (49 mm)
 Holder Base: 3-1/16" x 3-1/2" (78 mm x 89 mm)
 Floor Strike: 2-3/16" x 4-1/8" (56 mm x 105 mm)
 Strike Height: 2-1/4" (57 mm)
 Max Door to Floor Clearance: 1-1/8" to 1-9/16" (29 mm to 40 mm)
 Materials: Cast brass
 Finishes: US3, US10, US10B, US26, US26D
 Fasteners: Three (3) #14 x 1-1/2" FPHWS, three (3) 1/4-20 x 3/4" FPHMS, three (3) 1/4-20 lead anchors, four (4) 12-24 x 1" TPHMS, and four (4) #12 x 1" TPHWS

- Notes:
- For use on wood or metal doors and wood or concrete floors
 - Ideal for heavy traffic situations that require frequent hold open
 - Firm pull releases holding mechanism
 - Holder has vertical adjustment once mounted on the door



329F

Automatic Floor Stop and Holder

Certification: Meets ANSI A156.16 for L01301
 Holder Projection: 1-15/16" (49 mm)
 Holder Base: 3-1/16" x 3-1/2" (78 mm x 89 mm)
 Floor Strike: 2-3/16" x 4-1/8" (56 mm x 105 mm)
 Strike Height: 2-3/4" (70 mm)
 Max Door to Floor Clearance: 1-5/8" to 2-1/16" (41 mm to 52 mm)
 Materials: Cast brass
 Finishes: US3, US10, US10B, US26, US26D
 Fasteners: Three (3) #14 x 1-1/2" FPHWS, three (3) 1/4-20 x 3/4" FPHMS, three (3) 1/4-20 lead anchors, four (4) 12-24 x 1" TPHMS, and four (4) #12 x 1" TPHWS

- Notes:
- For use on wood or metal doors and wood or concrete floors
 - Ideal for heavy traffic situations that require frequent hold open
 - Firm pull releases holding mechanism
 - Holder has vertical adjustment once mounted on the door



KICK DOWN DOOR STOPS



270C

Kick Down Door Holder

- Certification: Meets ANSI A156.16 for L71382
 Base: 1-7/16" x 2-1/8" (37 mm x 54 mm)
 Arm: 3-13/16" (97 mm)
 Materials: Cast iron with rubber tip
 Finishes: S1 - Sprayed Aluminum, S2 - Sprayed Brass, S3 - Sprayed Bronze
 Fasteners: Four (4) #6 x 3/4" OPH tapping screws
 Notes:
 - Provides simple hold and release with a touch of the foot
 - 2-1/4" (57 mm) max door to floor clearance



270D

Kick Down Door Holder

- Certification: Meets ANSI A156.16 for L01381
 Base: 1-19/32" x 1-25/32" (41 mm x 45 mm)
 Arm: 3-1/2" (89 mm)
 Materials: Cast brass with rubber tip
 Finishes: US3, US10, US10B, US15, US15A, US19, US26, US26D
 Fasteners: Three (3) #6 x 3/4" OPHWS
 Notes:
 - Provides simple hold and release with a touch of the foot
 - 2-1/4" (57 mm) max door to floor clearance



270R

Replacement Rubber Tip

- Materials: Rubber
 Notes:
 - For use with 270D and 271D
 - Sold in packs of 10



270CR

Replacement Rubber Tip

- Materials: Rubber
 Notes:
 - For use with 270C
 - Sold in packs of 6



271D

Kick Down Door Holder

- Certification: Meets ANSI A156.16 for L01381
 Base: 1-19/32" x 1-25/32" (41 mm x 45 mm)
 Arm: 4-7/16" (87 mm)
 Materials: Cast brass with rubber tip
 Finishes: US3, US10, US10B, US26, US26D
 Fasteners: Three (3) #6 x 3/4" OPHWS
 Notes:
 - Provides simple hold and release with a touch of the foot
 - 3-1/4" (83 mm) max door to floor clearance





SURFACE BOLTS



275D | 276D

Surface Bolt

Certification: Meets ANSI A156.16 for L04161
 Overall Projection: 1-3/8" (35 mm)
 Overall Width: 2-1/32" (52 mm)
 Bar: 3/4" x 1/4" (19 mm x 6 mm) thick
 Length: 275D - 8" (203 mm)
 276D - 12" (305 mm)
 Throw: 1" (25 mm)
 Materials: Steel
 Finishes: US3, US10, US10B, US26D
 Fasteners: Eight (8) #10 x 1-1/4" FPHWS and eight (8) 10-24 x 1" undercut FPHMS



Notes:

- Mortise bottom strike and universal top strike included
- Strong tension springs prevent creep
- UL listed for use on inactive leaf of a pair of 3-HR labeled fire doors



278D

Surface Bolt

Bolt Length: 6" (152 mm)
 Bolt Width: 7/16" (11 mm)
 Bolt Throw: 31/32" (25 mm)
 Base Width: 19/32" (15 mm)
 Knob Diameter: 1/2" (13 mm)
 Projection: 3/4" (19 mm)
 Materials: Brass
 Finishes: US3, US10B, US26D
 Fasteners: Four (4) #5 x 5/8" FPHWS

Notes:

- Mortise and universal strikes included
- Concealed screw design enhances appearance and security
- Permanent stop prevents bolt disengagement from track



279D

Surface Bolt

Length: 4" (102 mm)
 Width: 1-11/16" (43 mm)
 Throw: 3/8" (10 mm)
 Half Round Bolt Size: 5/8" (16 mm)
 Projection: 1-1/4" (32 mm)
 Knob Diameter: 29/32" (23 mm)
 Materials: Brass
 Finishes: US3, US10, US10B, US26D
 Fasteners: Twelve (12) #6 x 3/4" FPHWS

Notes: Mortise and universal strikes included

FLUSH BOLTS & COORDINATING DEVICES



280X Dust Proof Strike

Certification:	Meets ANSI A156.16 for L04021
Face Plate:	1-7/16" x 2-29/32" x 1/8" depth (37 mm x 74 mm x 3 mm)
Barrel Diameter:	1" (25 mm)
Barrel Depth:	2-3/16" (56 mm)
Plunger Diameter:	3/4" (19 mm)
Materials:	Brass
Finishes:	US3, US4, US9, US10, US10B, US15, US15A, US19, US26, US26D
Fasteners:	Two (2) #8 x 1" FPHWS, two (2) plastic anchors, and spanner wrench
Notes:	<ul style="list-style-type: none"> • Packed unassembled with plate, strike, fasteners, and spanner wrench • May be used with carpet or threshold application by omitting face plate • Designed for use with the bottom bolt of a flushbolt set • Spring loaded plunger returns to floor or threshold level anytime flushbolt is retracted, eliminating the need to clean out the bottom strike



281D Slide Flush Bolt

Certification:	Meets ANSI A156.16 for L04201
Faceplate:	3/4" x 6" (19 mm x 153 mm)
Bolt Diameter:	1/2" (13 mm)
Bolt Throw:	1" (25 mm)
Bolt Backset:	7/16" (11 mm)
Strike:	7/8" x 1-3/4" (22 mm x 45 mm)
Materials:	Brass, bronze faceplate with steel components
Finishes:	US3, US4, US5, US10, US10B, US15, US15A, US19, US26, US26D
Fasteners:	Four (4) #6 x 3/4" FPHWS
Notes:	Double action spring design provides automatic holding of bolt in projected or retracted position



282D Manual Flush Bolt

Certification:	<ul style="list-style-type: none"> • Fits ANSI A115 door and frame prep • Meets ANSI A156.16 for L14251
Face Plate:	1" x 6-3/4" (25 mm x 172 mm)
Bolt Head:	1/2" (13 mm) square
Bolt Throw:	3/4" (19 mm)
Standard Rod Length:	12" (305 mm) (center of face to corner of door)
Bolt Backset:	3/4" (19 mm)
Mortise Strike:	15/16" x 2-1/4" (24 mm x 57 mm)
Materials:	Brass faceplate with steel components
Finishes:	US3, US4, US5, US9, US10, US10B, US15, US15A, US19, US26, US26D
Fasteners:	Eight (8) #8 x 3/4" combo screws; eight (8) #8 x 1-1/2" combo screws
Notes:	<ul style="list-style-type: none"> • For use on hollow metal/fire-rated doors • Non-handed • Bolt head rods are adjustable • Sold in increments of two • 3 hour fire rating for metal doors up to 4 feet wide by 10 feet tall • 282S strike plate bag and 282P bolt head available • Specify 282R for optional rod length of 18" (457 mm), 24" (610 mm), or 30" (762 mm) (bolt head not included)





FLUSH BOLTS & COORDINATING DEVICES



283D

Manual Flush Bolt

- Certification: Meets ANSI A156.16 for L14261
 Face Plate: 1" x 6-25/32" (25 mm x 172 mm)
 Bolt Head: 1/2" (13 mm) square
 Bolt Throw: 3/4" (19 mm)
 Bolt Backset: 3/4" (19 mm)
 Mortise Strike: 15/16" x 2-1/4" (24 mm x 57 mm)
 Materials: Brass faceplate with steel components
 Finishes: US3, US4, US5, US9, US10, US10B, US15, US15A, US19, US26, US26D
 Fasteners: Eight (8) #8 x 3/4" combo screws
 Notes:
 - For use on wood composite/ fire-rated doors
 - Non-handed
 - Bolt head rods are adjustable
 - 1-1/2 hour fire rating for wood doors up to 4 feet wide by 10 feet tall

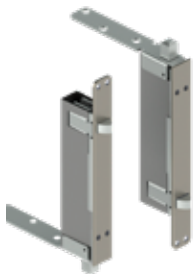

291D

Automatic Flush Bolt Set for Wood Covered Composite Doors

- Certification: B, C, D, and E Label
 ANSI A156.3 Type #25
 Face Plate: 1" x 8-1/2" (25 mm x 216 mm)
 Bolt Head: 1/2" (13 mm) square
 Bolt Throw: 3/4" (19 mm)
 Bolt Backset: 3/4" (19 mm)
 Mortise Strike: 15/16" x 2-1/4" (24 mm x 57 mm)
 Materials: Stainless steel and brass with steel components
 Finishes: US3, US4, US10, US10B, US15, US32, US32D
 Fasteners: Six (6) #8 x 1" combo screws, three (3) #10 x 1" SMS, and two (2) plastic anchors
 Notes:
 - Thermal lock automatically locks inactive door under high fire/heat conditions
 - 280X dust proof strikes are recommended for use with these sets
 - Used in pairs at top and bottom of inactive door
 - Fully automatic – bolts retract when active door is opened; bolts extend when active door is closed
 - Non-handed
 - Bolt head rods are adjustable
 - 1-1/2 hour fire rating for wood doors up to 4 feet wide by 9 feet tall

FLUSH BOLTS & COORDINATING DEVICES

292D

Automatic Flush Bolt Set for Metal Doors

Certification: A, B, C, D, and E Label
ANSI A156.3 Type #25

Face Plate: 1" x 6-3/4" (27 mm x 172 mm)

Bolt Head: 1/2" (13 mm) square

Bolt Throw: 3/4" (19 mm)

Bolt Backset: 3/4" (19 mm)

Mortise Strike: 15/16" x 2-1/4" (24 mm x 57 mm)

Materials: Stainless steel and brass with steel components

Finishes: US3, US4, US10, US10B, US15, US32, US32D

Fasteners: Ten (10) #8 x 1" combo screws

Notes:

- Thermal lock automatically locks inactive door under high fire/heat conditions
- 280X dust proof strikes are recommended for use with these sets
- Used in pairs at top and bottom of inactive door
- Fully automatic – bolts retract when active door is opened; bolts extend when active door is closed
- Non-handed
- Bolt head rods are adjustable
- 3-hour fire rating for metal doors up to 4 feet wide by 9 feet tall



293D

Constant-Latching Flush Bolt Set for Inactive Metal Doors

Certification: A, B, C, D, and E Label
ANSI A156.3 Type #27

Face Plate: 1" x 6-3/4" (25 mm x 172 mm)

Bolt Head: 1/2" (13 mm) square

Bolt Throw: 3/4" (19 mm)

Bolt Backset: 3/4" (19 mm)

T- Strike: 1-1/8" x 2-3/4" (28 mm x 70 mm)

Materials: Stainless steel and brass with steel components

Finishes: US3, US4, US10, US10B, US15, US32, US32D

Fasteners: Eight (8) #8 x 1" combo screws

Notes:

- Thermal lock automatically locks inactive door under high fire/heat conditions
- 280X dust proof strikes are recommended for use with these sets
- Consists of one 292S and one 293S for two point latching
- Inactive door remains latched until the active door is opened, releasing the automatic bottom bolt - Top bolt can be manually released by pressing plunger - Inactive door will relatch automatically when closed
- Non-handed
- Bolt head rods are adjustable
- 3-hour fire rating for metal doors up to 4 feet wide by 9 feet tall





FLUSH BOLTS & COORDINATING DEVICES



294D

Constant-Latching Flush Bolt Set for Inactive Wood Covered Composite Doors

- Certification: B, C, D, and E Label
ANSI A156.3 Type #27
- Face Plate: 1" x 8-1/2" (25 mm x 216 mm)
- Bolt Head: 1/2" (13 mm) square
- Bolt Throw: 3/4" (19 mm)
- Bolt Backset: 3/4" (19 mm)
- T- Strike: 1-1/8" x 2-3/4" (28 mm x 70 mm)
- Materials: Stainless steel and brass with steel components
- Finishes: US3, US4, US10, US10B, US15, US32, US32D
- Fasteners: Four (4) #8 x 1" combo screws, three (3) #10 x 1" SMS, and two (2) plastic anchors
- Notes:
 - Thermal lock automatically locks inactive door under high fire/heat conditions
 - 280X dust proof strikes are recommended for use with these sets
 - May be used on doors 4 ft. wide and 9 ft. high
 - Consists of one 291S and one 294S for two point latching
 - Inactive door remains latched until the active door is opened, releasing the automatic bottom bolt - Top bolt can be manually released - Inactive door will relatch automatically when closed
 - Non-handed
 - Bolt head rods are adjustable
 - 1-1/2 hour fire rating for wood doors up to 4 feet wide by 9 feet tall



295M

Automatic Flush Bolt Set with Fire Bolt for Metal Doors

- Certification: ANSI/BHMA 156.3 Type #25
- Face Plate: 1" x 6-3/4" (25 mm x 172 mm)
- Bolt Head: 1/2" (13 mm) square
- Bolt Throw: 3/4" (19 mm)
- Bolt Backset: 3/4" (19 mm)
- Mortise Strike: 15/16" x 2-1/4" (24 mm x 57 mm)
- Materials: Stainless steel and brass with steel components
- Finishes: US3, US4, US10, US10B, US15, US32, US32D
- Fasteners: Ten (10) #8 x 1" combo screws
- Notes:
 - Fire bolt is activated at 230° Fahrenheit projecting into active door locking leaves together - This combination eliminates the bottom flushbolt and eliminates floor preparation
 - Fully automatic – Bolt retracts when active door is opened - Bolt extends when active door is closed
 - Non-handed
 - Bolt head rods are adjustable
 - 3-hour fire rating for metal doors up to 4 feet wide by 9 feet tall



FLUSH BOLTS & COORDINATING DEVICES



295W

Automatic Flush Bolt Set with Fire Bolt for Wood Doors

- Certification: ANSI/BHMA 156.3 Type #25
 Face Plate: 1" x 8-1/2" (25 mm x 216 mm)
 Bolt Head: 1/2" (13 mm) square
 Bolt Throw: 3/4" (19 mm)
 Bolt Backset: 3/4" (19 mm)
 Mortise Strike: 15/16" x 2-1/4" (24 mm x 57 mm)
 Materials: Stainless steel and brass with steel components
 Finishes: US3, US4, US10, US10B, US15, US32, US32D
 Fasteners: Six (6) #8 x 1" combo screws, three (3) #10 x 1" SMS, and two (2) plastic anchors
- Notes:
- Fire bolt is activated at 230° Fahrenheit projecting into active door locking leaves together - This combination eliminates the bottom flushbolt and eliminates floor preparation
 - Fully automatic – Bolt retracts when active door is opened - Bolt extends when active door is closed
 - Non-handed
 - Bolt head rods are adjustable
 - 20-min fire rating for wood doors up to 4 feet wide by 9 feet tall



296W

Automatic Flush Bolt Set for Wood Doors

- Certification: ANSI/BHMA 156.3 Type #25
 Face Plate: 1-1/8" x 2-1/4" (29 mm x 57 mm)
 Bolt Head: 1/2" (13 mm) diameter
 Bolt Throw: 3/4" (19 mm)
 Bolt Backset: 1-1/2" (39 mm)
 Materials: Stainless steel and brass with steel components
 Finishes: US3, US4, US10, US10B, US15, US32, US32D
 Fasteners: Four (4) #8 x 1" SMS, two (2) #8 x 3/4" combo screws, two (2) plastic anchors
- Strike: 1-1/8" x 2-1/4" (29 mm x 57 mm)
- Notes:
- Non-handed
 - ADA compliant
 - Ideal for wood veneer doors
 - Only two (2) 1-1/8" diameter holes needed for easier door preparation
 - Opening active door retracts top and bottom bolts
 - Smaller profile adds stability to the door
 - 1-1/2 hour fire rating for doors up to 4 feet wide by 9 feet tall





FLUSH BOLTS & COORDINATING DEVICES



297C Carry Bar

Certification:
Projection:
Base:
Materials:
Finishes:
Fasteners:
Notes:

ANSI/BHMA A156.3 Type #27

25/32" (20 mm)

1-3/4" x 2-1/4" (45 mm x 57 mm)

Brass and stainless steel

USP, US3, US10, US10B, US15, US32, US32D

Two (2) 12-24 x 3/4" PPHMS w/ sex nuts

- Used when it is possible for the inactive door to be opened before the active door
- For use on pairs of doors with astragals
- For use in conjunction with a 297D or 298D coordinator
- Prevents damage to the doors and other hardware
- Carry bar is not required when the inactive door is equipped with automatic or self-latching flushbolts
- Non-handed



297D Coordinating Device

Certification:
Base:
Maximum Astragal Overlap:
Stop Height:
Materials:
Finishes:
Fasteners:



Notes:

ANSI/BHMA A156.3 Type #21A

1-5/8" x 5/8" (41 mm x 16 mm)

1" (25 mm)

5/8" (16 mm)

Steel

Black Prime Coat

Seven (7) 12-24 x 1-1/4" TPHMS and four (4) #8 x 1" FPH combo screws

- For use with overall frame widths 60" (1524 mm), 72" (1829 mm), or 96" (2438 mm), consult Hager Customer Service if overall frame width is different than our stock sizes
- Coordinating device is 52" (1321 mm) long for all stock sizes 60" (1524 mm), 72" (1829 mm), or 96" (2438 mm)
- Filler bar is cut to length by factory to match customers overall frame width
- Non-handed
- Designed for use on pairs of doors when one door needs to close before the other
- Active door lever, located nearest to the active stop, holds the active door open until the trigger mechanism is released by the closing of the inactive leaf
- Coordinator may not span the entire length of stop, 297F filler bar may be needed to fill up the extra space
- Compatible with flushbolts
- Optional mounting brackets 297M and 297N may be used when mounting other soffit applied hardware
- For use with active door widths 30" (762 mm) – 48" (1219 mm)
- If active and inactive doors are unequal in length, consult Hager Customer Service for proper sizing
- Do not use spring hinges with coordinating device

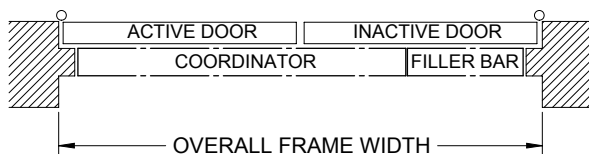



FLUSH BOLTS & COORDINATING DEVICES



297F

Filler Bar

Stop Height: 5/8" (16 mm)
 Material: Steel
 Finishes: Black prime coat
 Length: 18-5/8" (473 mm) (for jamb opening widths 52" – 72");
 42-5/8" (1082 mm) (for jamb opening widths 73" – 96")
 Notes: For use with 297D coordinator



297M

Mounting Bracket

Jamb Depth: 4-3/4" (121 mm)
 Stop Height: 5/8" (16 mm)
 Material: Aluminum
 Finishes: Black prime coat
 Fasteners: Four (4) 12-24 x 2" FPHMS and four (4) 1/4-20 x 1/2" FPHMS
 Notes:

- For use with 297D coordinator
- For soffit width 1-3/8" (35 mm) - 2-3/8" (60 mm)
- Allows soffit mounted hardware to be properly installed without damaging the coordinator, such as a parallel arm closer or a non-fire-rated surface vertical rod strike



297N

Mounting Bracket

Stop Height: 5/8" (16 mm)
 Material: Aluminum
 Finishes: Black prime coat
 Fasteners: Four (4) 12-24 x 2" FPHMS and four (4) 1/4-20 x 1/2" FPHMS
 Notes:

- For use with 297D coordinator
- For soffit width 3" (76 mm) or greater
- Allows soffit mounted hardware to be properly installed without damaging the coordinator, such as a parallel arm closer or a non-fire-rated surface vertical rod strike



298D

Gravity Coordinator

Certification: ANSI A156.3 Type #21B
 Base: 5-1/2" x 1-1/8" (140 mm x 29 mm)
 Projection: 7" (178 mm)
 Rail Height: 2-1/2" (64 mm) min
 Materials: Cast brass with rubber roller and nylon cam roller
 Finishes: US3, US10, US10B, US26D
 Fasteners: Two (2) #12 x 1" OPHWS, two (2) #6 x 3/4" FPHWS, two (2) #8 x 3/4" TPHWS, and one (1) #6 x 3/4" FPHWS
 Notes:

- Non-handed
- Recommended for use with flush top metal doors only
- Use automatic flush bolts only
- Use 297D if using self latching flush bolts
- Gravity arm and door bracket are adjustable on the job for ease of installation
- For use on pairs of doors with astragal on active door up to 4' (1219 mm) wide or with astragal on inactive door up to 3'-4" (1016 mm) wide or with astragal on both doors up to 2'-10" (864 mm) wide
- Maximum astragal overlap - 7/8" (22 mm)
- Do not use spring hinges with coordinating device





LATCHES & PROTECTION PLATES



311H | 311L Push/Pull Latch

- Certification: ANSI A156.2 Closest Equivalent (Bored Latch - Series 4000 - Grade 2)
- Push & Pull Levers: 1-15/16" x 4-1/2" (49 mm x 114 mm)
- Escutcheons: 3-1/16" x 5" (78 mm x 127 mm)
- Projection: 2-5/8" (67 mm)
- Bolt Throw: 1/2" (13 mm)
- Bolt Diameter: 3/4" (19 mm)
- Backset:
 - 2-3/4" (70 mm) - Standard
 - 5" (127 mm) - Optional
- Strike (TEE) - standard: 1-1/8" x 2-3/4" (29 mm x 70 mm)
- Strike (ASA) - standard: 1-1/4" x 4-7/8" (32 mm x 124 mm)
- Door thickness: 1-3/4" (45 mm)
- Materials: Zinc and stainless steel
- Finishes: US26, US26D, US32, US32D
- Notes:
 - Non-handed
 - Engraving is optional
 - 311L is same as 311H but for use on lead lined doors

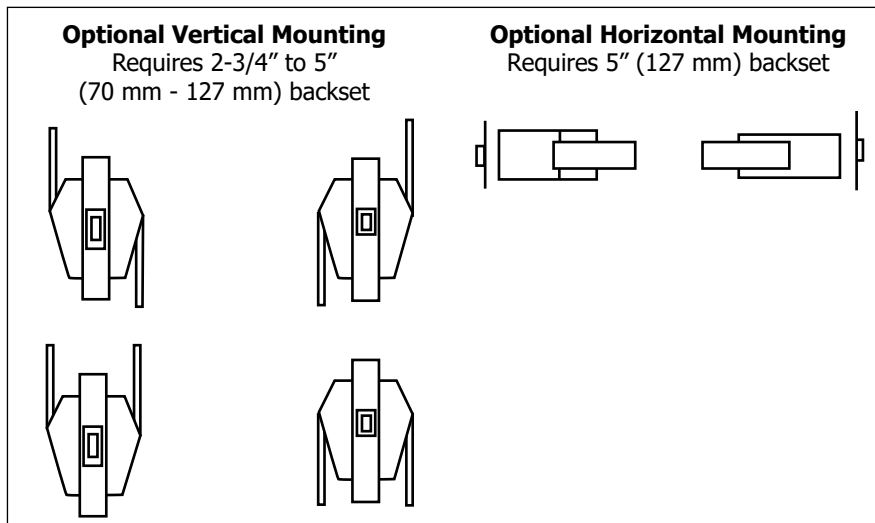

318D Roller Latch with Tee Strike

- Certification: Meets ANSI A156.16 for E09091
- Roller Faceplate: 1" x 3-3/8" (25 mm x 86 mm)
- Strike: 1-1/8" x 2-3/4" (29 mm x 70 mm)
- Strike Gauge: 0.171" (4.3 mm)
- Materials: Brass
- Finishes: US3, US4, US10, US10B, US15, US19, US26, US26D
- Fasteners: Two (2) #10 x 1-1/2" FPHWS, two (2) #8 x 1" FPHWS, and two (2) 8-32 x 3/4" FPHMS
- Notes:
 - Adjustable spring tension with nylon roller
 - Projection of roller is easily adjusted using screws on faceplate
 - Max projection of the roller is 3/8" (9.5 mm) allowing for variance in door and frame clearance

LATCHES & PROTECTION PLATES



318S

Roller Latch with Stop

- Certification: Meets ANSI A156.16 for E0911
- Roller Faceplate: 1-7/16" wide x 4-7/16" high x 11/16" angle (37 mm x 111 mm x 18 mm)
- Strike: 1-1/8" x 2-1/4" (29 mm x 57 mm)
- Strike Gauge: 0.171" (4.3 mm)
- Materials: Brass
- Finishes: US3, US4, US10, US10B, US15, US26, US26D
- Fasteners: Two (2) #10 x 1-1/2" FPHWS and two (2) 8-32 x 3/4" FPHMS
- Notes:
 - Adjustable spring tension with nylon roller
 - Projection of roller is easily adjusted using screws on faceplate
 - Max projection of the roller is 3/8" (9.5 mm) allowing for variance in door and frame clearance



320R

Roller Catch with Tee Strike

- Certification: Meets ANSI A156.16 for E0910
- Roller Faceplate: 1-1/8" x 2-1/4" (29 mm x 57 mm)
- Strike: 1-1/4" x 2-3/4" x 1/16" thick (32 mm x 70 mm x 1.5 mm)
- Materials: Brass
- Finishes: US3, US4, US10, US10B, US15, US26, US26D
- Fasteners: Four (4) #8 x 1" FPHWS
- Notes:
 - Adjustable spring tension with nylon roller
 - Projection of roller is adjusted by turning knurled knob on back of the latch
 - Max projection of the roller is 7/16" (11 mm) allowing for variance in door and frame clearance
 - For use with wood door and frame



321R

Adjustable Ball Catch with Strike

- Roller Faceplate: 1" x 2-1/8" (25 mm x 54 mm)
- Strike: 1-1/2" x 2-1/8" (38 mm x 54 mm)
- Strike Gauge: 0.050" (1.3 mm)
- Materials: Brass with steel ball
- Finishes: US3, US4, US10, US10B, US15, US15A, US19, US26D
- Fasteners: Four (4) #6 FPHWS
- Notes:
 - Adjustable threaded barrel compensates for various door clearances
 - Adjustable spring tension
 - For use with wood door and frame



323S

Three-Way Ball Catch

- Certification: Meets ANSI/BHMA 156.9.B13302
- Body: 1/2" W x 2-3/16" H x 1/2" D
- Strike:
 - 3/8" W x 1-3/8" H x 5/8" D
 - Plate type strike
- Materials: Brass with steel balls
- Finish: US26D
- Notes:
 - Adjustable spring tension is easily adjusted to suit field conditions
 - Body can be surface applied or mortised





LATCHES & PROTECTION PLATES



340D

Latch Protection Plate

- Size: 3" x 11" (76 mm x 279 mm)
 Materials: 12 gauge steel, stainless steel
 Finishes: US2C, US32D
 Fasteners: Two (2) 5/16-20 x 1-1/2" carriage bolts with sex nuts
 Notes:
 - For use with 1-3/4" (45 mm) doors
 - Non-handed
 - Frame pin prevents prying of door
 - For use with most mortise locks
 - For use with cylindrical locksets with a 3-3/4" (95 mm) backset or greater



341C

Latch Protection Plate with Lock Cut Out (no frame pins)

- Size: 3" x 11" (76 mm x 279 mm)
 Materials: 12 gauge steel, stainless steel
 Finishes: US32D
 Fasteners: Two (2) 5/16-20 x 1-1/2" carriage bolts with sex nuts
 Notes:
 - For use with 1-3/4" (45 mm) doors
 - Non-handed
 - For use with cylindrical locksets with a 2-3/4" (70 mm) backset



341D

Latch Protection Plate with Lock Cut Out

- Size: 3" x 11" (76 mm x 279 mm)
 Materials: 12 gauge steel, stainless steel
 Finishes: US2C, US32D
 Fasteners: Two (2) 5/16-20 x 1-1/2" carriage bolts with sex nuts
 Notes:
 - For use with 1-3/4" (45 mm) doors
 - Non-handed
 - Frame pin prevents prying of door
 - For use with cylindrical locksets with a 2-3/4" (70 mm) backset



342D

Latch Protection Plate with Escutcheon Cut Out

- Size: 3" x 11" (76 mm x 279 mm)
 Materials: 12 gauge steel, stainless steel
 Finishes: US2C, US32D
 Fasteners: Two (2) 5/16-20 x 1-1/2" carriage bolts with sex nuts
 Notes:
 - For use with 1-3/4" (45 mm) doors
 - Non-handed
 - For use with cylindrical and mortise locks with a 2-3/4" (70 mm) backset



345D

Latch Protection Plate

- Size: 1-5/8" x 10" (41 mm x 254 mm)
 Materials: 12 gauge steel, stainless steel
 Finishes: US2C, US32D
 Fasteners: Two (2) 5/16-20 x 1-1/2" carriage bolts with sex nuts
 Notes:
 - For use with 1-3/4" (45 mm) doors
 - Non-handed
 - For use with cylindrical and mortise locks

LATCHES & PROTECTION PLATES



1442

Roller Latch with Full Lip Strike

- Certification: Meets ANSI A156.16 for E09091
Roller Faceplate: 1" x 3-3/8" (25 mm x 86 mm)
Strike: 1-11/16" x 2-1/4" (43 mm x 57 mm)
Strike Gauge: 5/32" (4 mm)
Materials: Brass
Finishes: US3, US4, US10, US10B, US15, US15A, US19, US26, US26D
Fasteners: Two (2) #10 x 1-1/2" FPHWS, two (2) #8 x 1" FPHWS, and two (2) 8-32 x 3/4" FPHMS
Options: Non-ferrous available with extended lead time
Notes:
 - Adjustable spring tension with nylon roller
 - Projection of roller is easily adjusted using screws on faceplate
 - Max projection of the roller is 3/8" (9.5 mm) allowing for variance in door and frame clearance
 - For use with 1-3/8" doors only



1443

Roller Latch with ASA Strike

- Certification: Meets ANSI A156.16 for E09101
Roller Faceplate: 1" x 3-3/8" (25 mm x 86 mm)
Strike: 1-1/4" x 4-7/8" (32 mm x 124 mm)
Strike Gauge: 0.090" (2.3 mm)
Materials: Brass
Finishes: US3, US4, US10B, US15, US15A, US19, US26, US26D
Fasteners: Two (2) #10 x 1-1/2" FPHWS, two (2) #12 x 3/4" FPHWS, and two (2) 12-24 x 1/2" FPHMS
Notes:
 - Adjustable spring tension with nylon roller
 - Projection of roller is easily adjusted using screws on faceplate
 - Max projection of the roller is 3/8" (9.5 mm) allowing for variance in door and frame clearance



COAT HOOKS



901P
Coat Hook - Short Single
 Diameter: 1" (25 mm)
 Projection: 1-1/4" (32 mm)
 Materials: Brass
 Finishes: US3, US26D
 Fasteners: #14 x 1-1/4" wood thread
 Notes: Concealed mounting



937P
Coat Hook
 Projections:

- 3-3/4" (95 mm) top hook
- 2-1/2" (63 mm) bottom hook

 Materials: Brass
 Finishes: US3, US26D



902P
Coat Hook - Long Single
 Diameter: 1" (25 mm)
 Projection: 2-1/2" (63 mm)
 Materials: Brass
 Finishes: US3, US26D
 Fasteners: #14 x 1-1/4" wood thread
 Notes: Concealed mounting



940P
Coat Hook - Double
 Overall Height: 4-11/16" (119 mm)
 Top Projection: 3-15/16" (100 mm)
 Bottom Projection: 2-1/8" (54 mm)
 Material Thickness: 1/4" (6 mm)
 Materials: Brass
 Finishes: US3, US26D
 Fasteners: Two (2) #10 x 1" FPHWS



903P
Coat Hook - Long Double
 Diameter: 1" (25 mm)
 Projection: 2-1/2" (63 mm)
 Materials: Brass
 Finishes: US3, US26D
 Fasteners: #14 x 1-1/4" wood thread
 Notes: Concealed mounting



941P
Coat Hook - Single
 Overall Height: 2-5/16" (59 mm)
 Projection: 2-1/8" (54 mm)
 Material Thickness: 1/4" (6 mm)
 Materials: Brass
 Finishes: US3, US26D
 Fasteners: Two (2) #10 x 1" FPHWS



936P
Coat Hook Single Angled
 Base Diameter: 1-15/16" (49 mm)
 Hook Diameter: 11/16" (17 mm)
 Projection: 3-5/16" (84 mm)
 Materials: Brass
 Finishes: US3, US26D
 Notes: Concealed mounting



COAT HOOKS



945P
Double Coat Hook - Surface Mounting
 Overall Height: 5-1/2" (140 mm)
 Projection: 3-5/16" (84 mm)
 Materials: Brass
 Finishes: US3, US26D
 Fasteners: Four (4) #10 x 1" FPHWS w/ anchors



952P
Coat Hook - Single
 O/A Height: 2-13/16" (71 mm)
 Projection: 2-7/32" (56 mm)
 Materials: Brass
 Finishes: US3, US26D
 Notes: Concealed mounting



946P
Double Coat Hook - Concealed Mounting
 Overall Height: 5-1/2" (140 mm)
 Projection: 3-11/16" (94 mm)
 Materials: Brass
 Finishes: US3, US26D
 Fasteners: Two (2) #10 x 1" FPHWS w/ anchors
 Notes: Concealed mounting



956P
Double Coat Hook - Angled
 Overall Height: 5-11/16" (144 mm)
 Projection: 3-23/32" (95 mm)
 Materials: Brass
 Finishes: US3, US26D
 Notes: Concealed mounting



951P
Coat Hook - Double
 O/A Height: 5-3/4" (146 mm)
 Projection: 2-3/4" (70 mm)
 Materials: Brass
 Finishes: US3, US26D
 Notes: Concealed mounting



957P
Coat Hook
 Projection: 1-3/4" (45 mm)
 Base Diameter: 3/4" (19 mm)
 Materials: Brass
 Finishes: US3, US26D
 Fasteners: One (1) #10 x 1" wood thread
 Notes: Concealed mounting



PULLS - CLOSET/ POCKET/ SLIDING DOOR



22N

Concealed Edge Pull

Certification: Meets ANSI A156.14 for D2801
 Size: 31/32" x 4-1/4" x 3/8" thick (25 mm x 108 mm x 9.5 mm)
 Lever Extension: 2-19/32" (66 mm)
 Materials: Brass
 Finishes: US3, US26D
 Fasteners: Two (2) #6 x 3/4" FPHWS



330D

Pocket Door Latch

Certification: Meets ANSI A156.14 for D0821
 Size: 2-3/4" x 2-1/2" (70 mm x 64 mm)
 Extension of Finger Piece: 1-3/8" (35 mm)
 Materials: Brass
 Finishes: US3, US5, US10B, US15A, US19, US26, US26D
 Fasteners: Two (2) #6 x 5/8" OPHWS
 Notes: For use with 1-3/8" - 1-3/4" (35 mm - 45 mm) door



330L

Pocket Door Privacy Latch

Certification: Meets ANSI A156.14 for D0831
 Size: 2-3/4" x 2-1/2" (70 mm x 64 mm)
 Extension of Finger Piece: 1-3/8" (35 mm)
 Strike Size: 1" x 2-1/4" (25 mm x 57 mm)
 Materials: Brass
 Finishes: US3, US5, US10B, US15, US15A, US19, US26, US26D
 Fasteners: Two (2) #6 x 5/8" OPHWS and two (2) #6 x 3/4" FPHWS
 Notes: For use with 1-3/8" (35 mm) door



330M

Pocket Door Privacy Latch

Certification: Meets ANSI A156.14 for D0831
 Size: 2-3/4" x 2-1/2" (70 mm x 64 mm)
 Extension of Finger Piece: 1-3/8" (35 mm)
 Strike Size: 1" x 2-1/4" (25 mm x 57 mm)
 Materials: Brass
 Finishes: US3, US5, US10B, US15, US15A, US19, US26, US26D
 Fasteners: Two (2) #6 x 5/8" OPHWS and two (2) #6 x 3/4" FPHWS
 Notes: For use with 1-3/4" (45 mm) door



2610

Flush Cup Finger Pull

Overall Diameter: 31/32" (24.5 mm)
 Finger Pull Diameter: 3/4" (19 mm)
 Pull Clearance: 5/16" (8 mm)
 Projection: 1/32" (.8 mm)
 Materials: Solid brass
 Finishes: US3, US4, US5, US10A, US15, US15A, US26, US26D, ABA
 Notes:

- For use on bi-fold, by-pass or pocket applications
- Built-in prong design eliminates the need for screws or brads

PULLS - CLOSET/POCKET/SLIDING DOOR



2620

Flush Cup Pull

Overall Diameter: 2-1/16" (52 mm)
 Finger Pull Diameter: 1-11/16" (43 mm)
 Pull Clearance: 11/32" (8.7 mm)
 Projection: 5/64" (2 mm)
 Materials: Solid brass
 Finishes: US3, US4, US5, US10A, US15, US15A, US26, US26D, ABA
 Notes:

- For use on bi-fold, by-pass or pocket applications
- Built-in prong design eliminates the need for screws or brads



2630

Flush Cup Pull

Overall Diameter: 2-7/16" (62 mm)
 Finger Pull Diameter: 2-1/16" (52 mm)
 Pull Clearance: 11/32" (8.7 mm)
 Projection: 3/32" (2.4 mm)
 Materials: Solid brass
 Finishes: US3, US4, US5, US10A, US15, US15A, US26, US26D, ABA
 Notes:

- For use on bi-fold, by-pass or pocket applications
- Built-in prong design eliminates the need for screws or brads



2640

Oblong Flush Pull

Size: 1-5/16" x 2-3/4" (33 mm x 70 mm)
 Cup Clearance: 5/16" (8 mm)
 Materials: Solid brass
 Finishes: US3, US4, US5, US10A, US15, US15A, US26, US26D, ABA
 Fasteners: Two (2) #6 x 5/8" OPHWS
 Notes: For use on bi-fold, by-pass or pocket applications



9558

Wood Knob

Diameter: 1-1/2" (38 mm)
 Materials: Solid wood
 Notes:

- For use on bi-fold applications
- Will accept paint or stain



9566

Knob

Diameter: 1-1/4" (32 mm)
 Projection: 1" (25 mm)
 Materials: Die Cast Zinc
 Finishes: US3, US4, US5, US10A, US10B, US15, US15A, US26, US26D
 Fasteners: One (1) 8-32 x 1-3/4" PPHMS and one (1) 8-32 x 2" PPHMS
 Notes: For use on bi-fold applications on doors 3/4" (19 mm) to 1-3/8" (35 mm) thick





PULLS - CLOSET/POCKET/SLIDING DOOR



9567

Rose

- Base Diameter: 1-3/4" (45 mm)
 Projection: 15/32" (12 mm)
 Materials: Die cast zinc
 Finishes: US3, US4, US5, US10A, US10B, US15, US15A, US26, US26D
 Fasteners: One (1) 8-32 x 1-3/4" PPHMS and one (1) 8-32 x 2" PPHMS
 Notes:
 - For use on bi-fold applications on doors 3/4" (19 mm) to 1-3/8" (35 mm) thick
 - For use with 9566 knob



9865

Flush Cup Pull

- Overall Diameter: 1-31/32" (50 mm)
 Finger Pull Diameter: 1-19/32" (40 mm)
 Pull Clearance: 11/32" (8.7 mm)
 Projection: 5/64" (2 mm)
 Materials: Tan color ABS plastic
 Notes:
 - For use on bi-fold, by-pass or pocket applications
 - Built-in prong design eliminates the need for screws or brads



9882

Pocket Door Edge Pull

- Face Plate Size: 3/4" x 3 - 7/8" (19 mm x 98 mm)
 Finger Pull Extends: 3/4" (19 mm)
 Materials: Solid brass
 Finishes: US3, US4, US10, US10B, US26, US26D
 Fasteners: Two (2) #6 x 5/8" FPHWS
 Notes:
 - Ideal for narrow and standard door thicknesses
 - Automatic spring return



9884

Pocket Door Edge Pull

- Faceplate: 21/32" x 3-1/2" (16.5 mm x 89 mm)
 Finger Pull Extends: 1-1/16" (27 mm)
 Materials: Die cast zinc
 Finishes: US3
 Fasteners: Two (2) #6 x 5/8" FPHWS
 Notes: Ideal for narrow and standard door thicknesses

FILLER PLATES



336A
Door Edge Filler Plate - 161 Prep
 Size: 1-1/8" x 2-1/4"
 (29 mm x 57 mm)
 Thickness: 0.134" (3.4 mm)
 Materials: Primed steel



336G
Door Edge Filler Plate - Square
 Size: 1-3/4" x 5"
 (38 mm x 127 mm)
 Thickness: 0.134" (3.4 mm)
 Materials: Primed steel



336B
Door Edge Filler Plate - 86 Prep
 Size: 1-1/4" x 8"
 (32 mm x 203 mm)
 Thickness: 0.180" (4.5 mm)
 Materials: Primed steel



336H
Door Edge Filler Plate - Beveled
 Size: 1-1/2" x 5"
 (38 mm x 127 mm)
 Thickness: 0.134" (3.4 mm)
 Materials: Primed steel
 Notes: For handed doors



336C
Door Face Filler Plate
 Size: 1-3/4" (45 mm)
 diameter
 Thickness: 0.055" (1.4 mm)
 Materials: Primed steel



336J
Flush Bolt Strike Filler Plate - Frame
 Size: 15/16" x 2-1/4"
 (24 mm x 57 mm)
 Thickness: 0.083" (2.1 mm)
 Materials: Primed steel



336D
Door Face Filler Plate
 Size: 2-5/8" (67 mm)
 diameter
 Thickness: 0.055" (1.4 mm)
 Materials: Primed steel



336K
Flush Bolt Filler Plate - Door
 Size: 1" x 6-3/4"
 (25 mm x 172 mm)
 Thickness: 0.134" (3.4 mm)
 Materials: Primed steel



336E
Door Edge Filler Plate - Square
 Size: 1-3/4" x 4-1/2"
 (45 mm x 114 mm)
 Thickness: 0.134" (3.4 mm)
 Materials: Primed steel



336L
Hinge Filler Plate - Frame
 Size: 1-5/8" x 4-1/2"
 (41 mm x 114 mm)
 Thickness: 0.134" (3.4 mm)
 Materials: Primed steel



336F
Door Edge Filler Plate - Bevel
 Size: 1-1/2" x 4-1/2"
 (38 mm x 114 mm)
 Thickness: 0.134" (3.4 mm)
 Materials: Primed steel
 Notes: For handed doors



FILLER PLATES



336M
Hinge Filler Plate - Frame
 Size: 1-5/8" x 5"
 (41 mm x 127 mm)
 Thickness: 0.134" (3.4 mm)
 Materials: Primed steel



337A
Template Hinge Shim
 Size: 1-7/16" x 4-1/2"
 (37 mm x 114 mm)
 Thickness: 0.028" (0.7 mm)
 Materials: Primed steel



336N
Latch Adapter Filler Plate - 86 to 161
Edge Prep
 Size: 1-1/4" x 8"
 (32 mm x 203 mm)
 Thickness: 0.238" (6 mm)
 Materials: Primed steel



337B
Template Hinge Shim
 Size: 1-7/16" x 4-1/2"
 (37 mm x 114 mm)
 Thickness: 0.065" (1.7 mm)
 Materials: Primed steel



336P
Deadlock Strike Filler Plate - Frame
 Size: 1-1/8" x 2-3/4"
 (29 mm x 70 mm)
 Thickness: 0.083" (2.1 mm)
 Materials: Primed steel



337C
Template Hinge Shim
 Size: 1-7/16" x 5"
 (37 mm x 127 mm)
 Thickness: 0.028" (0.7 mm)
 Materials: Primed steel



336Q
ASA Strike Filler Plate - Frame
 Size: 1-1/4" x 4-7/8"
 (32 mm x 124 mm)
 Thickness: 0.093" (2.4 mm)
 Materials: Primed steel



337D
Template Hinge Shim
 Size: 1-7/16" x 5"
 (37 mm x 127 mm)
 Thickness: 0.065" (1.7 mm)
 Materials: Primed steel



336R
Cylindrical Lock Strike Filler Plate -
Frame
 Size: 1-1/8" x 2-3/4"
 (29 mm x 70 mm)
 Thickness: 0.083" (2.1 mm)
 Materials: Primed steel



SIGNAGE

PUSH

PULL

350H | 350L

Engraved Plastic Sign - Push (350H) and Pull (350L)

- Certification: Meets ANSI A156.16 L03201
 Materials: 0.125" (3.2 mm) thick plastic
 Lettering: 3/4" (19 mm) Helvetica
 Size: 2" x 4" (51 mm x 102 mm)
 Fasteners: Double-sided pressure sensitive tape or screws (specify)
 Colors:
 - Brown (W1) with white lettering
 - Black (W2) with white lettering
 - Blue (W3) with white lettering
 - Silver (B1) with black lettering
 - Gold (B2) with black lettering
 Notes: Signs are individually packed in a poly bag

MEN

WOMEN

350M | 350W

Engraved Plastic Sign - Men (350M) and Women (350W)

- Certification: Meets ANSI A156.16 L03201
 Materials: 0.125" (3.2 mm) thick plastic
 Lettering: 3/4" (19 mm) Helvetica
 Size: 2" x 5" (51 mm x 127 mm)
 Fasteners: Double-sided pressure sensitive tape or screws (specify)
 Colors:
 - Brown (W1) with white lettering
 - Black (W2) with white lettering
 - Blue (W3) with white lettering
 - Silver (B1) with black lettering
 - Gold (B2) with black lettering
 Notes: Signs are individually packed in a poly bag

635

350R

Engraved Plastic Sign - Number

- Certification: Meets ANSI A156.16 L03201
 Materials: 0.125" (3.2 mm) thick plastic
 Lettering: 3/4" (19 mm) Helvetica
 Size: 2" x 4" (51 mm x 102 mm)
 Fasteners: Double-sided pressure sensitive tape or screws (specify)
 Colors:
 - Brown (W1) with white lettering
 - Black (W2) with white lettering
 - Blue (W3) with white lettering
 - Silver (B1) with black lettering
 Notes:
 - Signs are individually packed in a poly bag
 - Please note numbers to be engraved when ordering

PUSH

PULL

351H | 351L

Engraved Plastic Sign - Push (351H) and Pull (351L)

- Certification: Meets ANSI A156.16 L03201
 Materials: 0.125" (3.2 mm) thick plastic
 Lettering: 3/4" (19 mm) Helvetica
 Size: 1" x 4-1/2" (25 mm x 114 mm)
 Fasteners: Double-sided pressure sensitive tape or screws (specify)
 Colors:
 - Brown (W1) with white lettering
 - Black (W2) with white lettering
 - Blue (W3) with white lettering
 - Silver (B1) with black lettering
 - Gold (B2) with black lettering
 Notes: Signs are individually packed in a poly bag





SIGNAGE



352M | 352W

Engraved Plastic Sign - Men (352M) and Women (352W)

Certification: Meets ANSI A156.16 L03201
Materials: 0.125" (3.2 mm) thick plastic
Lettering: 3/4" (19 mm) Helvetica
Size: 352M - 2-1/2" x 6" (64 mm x 152 mm)
 352W - 2-1/2" x 7" (64 mm x 178 mm)
Fasteners: Double-sided pressure sensitive tape or screws (specify)
Colors:

- Brown (W1) with white lettering
- Black (W2) with white lettering
- Blue (W3) with white lettering
- Silver (B1) with black lettering
- Gold (B2) with black lettering

Notes: Signs are individually packed in a poly bag



354A | 354B

Engraved Plastic Sign - Restroom(s)

Certification: Meets ANSI A156.16 L03201
Materials: 0.125" (3.2 mm) thick plastic
Lettering: 3/4" (19 mm) Helvetica
Size: 2" x 6" (51 mm x 127 mm)
Fasteners: Double-sided pressure sensitive tape or screws (specify)
Colors:

- Black (W2) with white lettering
- Blue (W3) with white lettering

Notes: Signs are individually packed in a poly bag



360M | 360W

Engraved Metal Sign - Men (360M) and Women (360W)

Certification: Meets ANSI A156.16 L03201
Materials: 0.050" (1.3 mm) thick metal
Lettering: 3/4" (19 mm) Helvetica black filled
Size: 2" x 6" (51 mm x 152 mm)
Fasteners: Double-sided pressure sensitive tape or screws (specify)
Finishes: US3, US28, US32D
Notes: Signs are individually packed in a poly bag

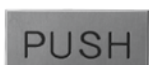
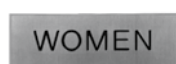

361H | 361L

Engraved Metal Sign - Push (361H) and Pull (361L)

Certification: Meets ANSI A156.16 L03201
Materials: 0.050" (1.3 mm) thick metal
Lettering: 3/4" (19 mm) Helvetica black filled
Size: 2" x 4" (51 mm x 102 mm)
Fasteners: Double-sided pressure sensitive tape or screws (specify)
Finishes: US3, US10B, US28, US32D
Notes: Signs are individually packed in a poly bag





SIGNAGE

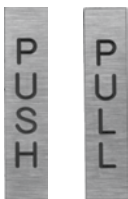

362H | 362L

Engraved Metal Sign - Push (362H) and Pull (362L)

Certification: Meets ANSI A156.16 L03201
 Materials: 0.050" (1.3 mm) thick metal
 Lettering: 3/4" (19 mm) Helvetica black filled
 Size: 1" x 4-1/2" (25 mm x 114 mm)
 Fasteners: Double-sided pressure sensitive tape or screws (specify)
 Finishes: US3, US10B, US28, US32D
 Notes: Signs are individually packed in a poly bag



364M | 364S

Plastic International Handicap Symbol

Certification: Meets ANSI A156.16 L03201
 Materials: 0.0625" (1.6 mm) thick plastic raised HANDICAP symbol
 Size: 364M - 4" x 4" (102 mm x 102 mm)
 364S - 3" x 3" (76 mm x 76 mm)
 Fasteners: Double-sided pressure sensitive tape standard or screws (specify)
 Colors: Blue (W3) with raised white symbol
 Notes: Signs are individually packed in a poly bag



364N

Engraved International No Smoking Symbol

Certification: Meets ANSI A156.16 L03201
 Materials: 0.125" (3.2 mm) thick plastic
 Size: 6" x 6" (152 mm x 152 mm)
 Fasteners: Pressure sensitive tape standard or screws (specify)
 Colors: Red (W4) with raised white symbol
 Notes: Signs are individually packed in a poly bag



364L

Plastic International Handicap Symbol

Certification: Meets ANSI A156.16 L03201
 Materials: 0.125" (3.2 mm) thick plastic 1/32" (0.8 mm) raised HANDICAP symbol
 Size: 6" x 6" (152 mm x 152 mm)
 Fasteners: Double-sided pressure sensitive tape standard or screws (specify)
 Colors:

- Brown (W4) with raised white symbol
- Black (W2) with raised white symbol
- Blue (W3) with raised white symbol

 Notes: Signs are individually packed in a poly bag



365M | 365W

ADA Tactile Signage - Men (365M) and Women (365W)

Certification: Meets ANSI A156.16 L03201
 Materials: 0.125" (3.2 mm) thick plastic
 Size: 6" x 8" (152 mm x 203 mm)
 Fasteners: Double-sided pressure sensitive tape
 Colors:

- Brown (W1) with raised white symbol
- Black (W2) with raised white symbol
- Blue (W3) with raised white symbol

 Notes:

- Signs are individually packed in a poly bag
- Grade 2 Braille Translation conforming to section 4.30 requirements





SIGNAGE

325

366R ADA Tactile Signage - Room Number

- Certification: Meets ANSI A156.16 L03201
 Materials: 0.125" (3.2 mm) thick plastic
 Size: 2-1/2" x 5" (64 mm x 127 mm)
 Fasteners: Double-sided pressure sensitive tape
 Colors:
 - Brown (W1) with raised white lettering
 - Black (W2) with raised white lettering
 - Blue (W3) with raised white lettering
 Notes:
 - Signs are individually packed in a poly bag
 - Grade 2 Braille Translation conforming to section 4.30 requirements
 - Please note numbers to be engraved when ordering



366S ADA Tactile Signage - Stairs

- Certification: Meets ANSI A156.16 L03201
 Materials: 0.125" (3.2 mm) thick plastic
 Size: 6" x 8" (152 mm x 203 mm)
 Fasteners: Double-sided pressure sensitive tape
 Colors:
 - Brown (W1) with white symbol and lettering
 - Black (W2) with white symbol and lettering
 - Blue (W3) with white symbol and lettering
 Notes:
 - Signs are individually packed in a poly bag
 - Grade 2 Braille Translation conforming to section 4.30 requirements



368E ADA Tactile Signage - Exit

- Certification: Meets ANSI A156.16 L03201
 Materials: 0.125" (3.2 mm) thick plastic
 Size: 6" x 8" (152 mm x 203 mm)
 Fasteners: Double-sided pressure sensitive tape
 Colors:
 - Brown (W1) with white symbol and lettering
 - Black (W2) with white symbol and lettering
 - Blue (W3) with white symbol and lettering
 Notes:
 - Signs are individually packed in a poly bag
 - Grade 2 Braille Translation conforming to section 4.30 requirements



368M | 368W ADA Tactile Signage - Men (365M) and Women (365W) with Handicap

- Certification: Meets ANSI A156.16 L03201
 Materials: 0.125" (3.2 mm) thick plastic
 Size: 6" x 8" (152 mm x 203 mm)
 Fasteners: Double-sided pressure sensitive tape
 Colors:
 - Brown (W1) with white symbol and lettering
 - Black (W2) with white symbol and lettering
 - Blue (W3) with white symbol and lettering
 Notes:
 - Signs are individually packed in a poly bag
 - Grade 2 Braille Translation conforming to section 4.30 requirements





SIGNAGE



368U

ADA Tactile Signage - Unisex

- Certification: Meets ANSI A156.16 L03201
- Materials: 0.125" (3.2 mm) thick plastic
- Size: 8" x 8" (203 mm x 203 mm)
- Fasteners: Double-sided pressure sensitive tape
- Colors:
 - Brown (W1) with white symbol and lettering
 - Black (W2) with white symbol and lettering
 - Blue (W3) with white symbol and lettering
- Notes:
 - Signs are individually packed in a poly bag
 - Grade 2 Braille Translation conforming to section 4.30 requirements



369L | 369R

ADA Tactile Signage - Access Left (369L) and Access Right (369R)

- Certification: Meets ANSI A156.16 L03201
- Materials: 0.125" (3.2 mm) thick plastic
- Size: 6" x 8" (152 mm x 203 mm)
- Fasteners: Double-sided pressure sensitive tape
- Colors:
 - Brown (W1) with white symbol and lettering
 - Black (W2) with white symbol and lettering
 - Blue (W3) with white symbol and lettering
- Notes:
 - Signs are individually packed in a poly bag
 - Grade 2 Braille Translation conforming to section 4.30 requirements



370U | 370W | 370M

ADA Tactile Signage - Restroom, Men, and Women

- Certification: Meets ANSI A156.16 L03201
- Materials: 9/16" (14.3 mm) plastic
- Size:
 - 370U - 12" (305 mm) diameter
 - 370W - 12" (305 mm) diameter
 - 370M - 10-1/2" (267 mm) side
- Fasteners: Double-sided pressure sensitive tape
- Color: Blue (W3) with white raised symbol and lettering
- Notes:
 - Signs are individually packed in a poly bag
 - Grade 2 Braille Translation conforming to section 4.30 requirements





MISCELLANEOUS



274B

Door Guard Protection Plate

- Size: 1-1/8" x 1" x 1/2" (28.5 mm x 25 mm x 12.5 mm)
 Materials: Brass
 Finishes: US3, US4, US10, US10B, US15, US26, US26D
 Notes:
 - Used when additional protective plate is required for frame application
 - Mounted with double-sided tape
 - To be used with the 274D



274C

Shim for Door Guard

- Size:
 - 1-1/16" X 1-5/8" (27 mm X 41 mm)
 - 1-1/8" x 1-1/16" (29 mm x 27 mm)
 Thickness: 3/32" (2.3 mm)
 Materials: Black rubber
 Notes: To be used with the 274D



274D

Door Guard

- Certification: Meets ANSI A156.16 for L13041
 Arm Length: 4-1/2" (114 mm)
 Materials: Brass
 Finishes: US3, US4, US10, US10B, US15, US26, US26D
 Fasteners: Three (3) #6 x 1-1/2" OPHWS, four (4) #6 x 3/4" OPHWS, and seven (7) 6-32 x 12" OPHMS
 Notes:
 - Permits door to be slightly opened to allow viewing
 - Hinged bar allows the door guard to be positioned 180 degrees away from the door when not in use
 - Includes door guard protective plate 274B



277D

Door Guard

- Certification:
 - Meets NFPA 80 5.2.13.3
 - Meets NFPA 80 5.2.4.2(9)
 - ADA Compliant Arm
 Size:
 - Base: 2-5/8" H x 1-9/16" W
 - Projection: 2-3/16"
 Materials: Cast zinc
 Finishes: US3, US4, US10B, US15, US26, US26D
 Fasteners:
 - Three (3) #12 x 1- 3/4" FPHSMS
 - Three (3) 12-24 machine screws
 Note: Release tool 277R sold separately



277F

Privacy Door Guard Bracket

- Materials:
 - Cold rolled steel
 Finish:
 - Primer gray
 Fasteners:
 - Five (5) 12-24 FPH Self-tapping. (Balance of three (3) fasteners supplied with the 277D)
 Notes:
 - For use with the decorative snap-on frames using Hager 277D Privacy Door Guard



MISCELLANEOUS



300D **Chain Door Check**

- Certification: Meets ANSI A156.16 for L02231
- Lengths:
- 25-1/2" (648 mm) recommended for use with 36" (914 mm) wide door
 - 30-1/2" (775 mm) recommended for use with 42" (1067 mm) wide door
- Base Plate: 1-1/2" x 1-1/2" (38 mm x 38 mm)
- Materials:
- Cast zinc base
 - Galvanized steel chain
 - EDPM rubber cover
- Finish: US26D
- Fasteners: Ten (10) #8 x 1" FPHSMS
- Notes:
- Tear resistant grey vinyl cover
 - Can be ordered through door mounting with grommet nut sets at extra charge
 - 440 pound load strength
 - Designed for full size exterior doors



MISCELLANEOUS



301D **Residential Stop**

- Certification: Meets ANSI A156.16 for L02223
Materials: Wrought steel with rubber bumpers
Finishes: 2C, US3
Notes:
 - Works with 1/4" (6 mm) and 5/16" (8 mm) hinge pins
 - For use where standard door stops are not desirable
 - Positive slip proof design
 - Adjustable from 70 degrees to 100 degrees
 - Must purchase an NRP hinge for use with this pinstop



303W **Handrail Bracket**

- Certification: Meets ANSI A156.16 for L03061
Base Diameter: 3-5/32" (80 mm)
Base to Center of Rail: 2-3/4" (70 mm)
Materials: Brass
Finishes: US3, US4, US10, US10B, US15A, US19, US26, US26D
Fasteners: Three (3) #10 x 1-1/4" FPHWS, three (3) plastic anchors, three (3) 10-24 x 13/16" FPHMS, and three (3) 10-24 lead anchors



305D **Wire Pull**

- Certification: Meets ANSI A156.9 for B02011
Diameter of Rod: 5/16" (7.9 mm)
Projection: 1-9/32" (32.5 mm)
CTC Lengths: 3" (76 mm), 3-1/2" (89 mm), 4" (102 mm)
Materials: Brass
Finishes: US3, US4, US10, US26, US26D
Fasteners: Two (2) 8-32 x 1" TPHMS



307D **Door Silencer**

- Certification: Meets ANSI A156.16 for L03011
Diameter: 1/2" (13 mm)
Projection: 1/8" (3 mm)
Materials: Rubber
Notes:
 - For use with metal frames
 - Proper installation eliminates door rattle and provides constant tension for door latches or locks



308D **Door Silencer**

- Certification: Meets ANSI A156.16 for L0302
Projection: 9/64" (3.5 mm)
Base: 3/8" x 3/4" (9.5 mm x 19 mm)
Length: 3/4" (19 mm)
Materials: Rubber
Notes:
 - For use with wood frames
 - Eliminates door rattle when door is latched
 - Proper installation eliminates door rattle and provides constant tension for door latches or locks





MISCELLANEOUS



310C Conversion Kit

- Filler Plate: 1-1-8" x 3-3/8" (29 mm x 86 mm)
 Strike: 1-11/16" x 2-1/4" (43 mm x 57 mm)
 Materials: Brass
 Finishes: US10B, US26D
 Notes:
 - Packed with filler plate, strike and fasteners
 - Change door from Roller Latch to Push/Pull Latch



322V Wrought Door Knocker with Viewer (115°)

- Certification: Meets ANSI A156.16 for L03163
 Size: 2-3/16" x 3-1/4" (56 mm x 83 mm)
 Materials: Brass
 Finishes: US3, US10, US26D
 Fasteners: Three (3) #6 x 3/4" TPHSMS
 Engraving: Available up to four characters
 Notes: Requires 1/2" (13 mm) hole for viewer



334V Door Knocker with Viewer (115°)

- Certification: Meets ANSI A156.16 for L03163
 Size: 3-9/16" x 6-3/4" (90.5 mm x 171.5 mm)
 Materials: Solid Cast Brass
 Finishes: US3, US4, US10, US10B, US26, US26D
 Fasteners:
 - Two (2) #8 finish washers
 - Two (2) 7-32 x 1-7/8" OHMS for 1-5/8" doors
 - Two (2) 7-32 x 2" OHMS for 1-3/4" doors
 Engraving: Available up to four characters



1755 115° Door Viewer

- Certification: Meets ANSI A156.16 for L03223
 Materials: Brass
 Finishes: US3, US4, US5, US10A, US15, US15A, US26, US26D
 Door Thickness: 1-3/8" - 2-1/8" thick, adjustable
 Notes:
 - For doors up to 2-1/8" (54 mm) thick, adjustable
 - Requires 1/2" (13 mm) hole for viewer
 - Tamper resistant
 - 90 minute fire-rated
 - One-way viewer



MISCELLANEOUS



1756 185° Door Viewer

- Certification: Meets ANSI A156.16 for L03223
 Materials: Brass
 Finishes: US3, US4, US5, US10A, US15, US15A, US26, US26D
 Notes:
 - For doors up to 2-1/8" (54 mm) thick, adjustable
 - Requires 9/16" (14 mm) hole for viewer
 - Tamper resistant
 - 90 minute fire-rated
 - One-way viewer



1758 115° Door Viewer with Privacy Flap

- Certification: Meets ANSI A156.16 for L03223
 Materials: Brass
 Finishes: US3, US10A, US26, US26D
 Notes:
 - Requires 1/2" (13 mm) hole for viewer
 - For doors 1-3/8" (35 mm) to 2-1/8" (54 mm) thick, adjustable
 - Tamper resistant
 - 90 minute fire-rated
 - One-way viewer
 - Flap diameter - 3/4"



1759 185° Door Viewer with Privacy Flap

- Certification: Meets ANSI A156.16 for L03223
 Materials: Brass
 Finishes: US3, US10A, US26, US26D
 Notes:
 - Requires 9/16" (14 mm) hole for viewer
 - For doors 1-3/8" (35 mm) to 2-1/8" (54 mm) thick, adjustable
 - Tamper resistant
 - 90 minute fire-rated
 - One-way viewer
 - Flap diameter - 3/4"



1765 Privacy Flap for Use with Hager 115° Door Viewer (1755)

- Materials: Brass
 Finishes: US3, US10A, US26, US26D
 Notes: Flap diameter - 3/4"



1766 Privacy Flap for Use with Hager 185° Door Viewer (1756)

- Materials: Brass
 Finishes: US3, US10A, US26, US26D
 Notes: Flap diameter - 3/4"





RESIDENTIAL



208

Kick Down Door Stop

- Base: 1-5/8" x 1-7/8" (41 mm x 48 mm)
 Arm: 3-7/8" (98 mm)
 Materials: Aluminum alloy
 Finishes: US3, US4, US5, US10A, US15A, US15, US26, US26D, ABA
 Fasteners: Three (3) #6 x 3/4" FPHWS
 Notes:
 - Poly bag (1 each) with screws
 - Provides simple hold and release with a touch of the foot
 - 3" (76 mm) max door to floor clearance



209

Floor Door Stop

- Height: 1-1/4" (32 mm)
 Base Diameter: 1-3/32" (28 mm)
 Tip Diameter: 19/32" (15 mm)
 Materials: Zinc alloy
 Finishes: US3, US4, US5, US10A, US15A, US15, US26, US26D, ABA
 Fasteners: One (1) #8 x 2" FPHWS
 Notes:
 - Non-marking white tip
 - 3/8" (9.5 mm) max door to floor clearance



210

Rigid Door Stop

- Projection: 3" (76 mm)
 Tip Diameter: 11/16" (17.5 mm)
 Base Diameter: 1" (25 mm)
 Materials: Zinc alloy
 Finishes: US3, US26, AN
 Fasteners: #8 x 5/8" thread
 Notes: Bumper made of rubber



211

Flexible Door Stop

- Projection: 3-1/8" (79 mm)
 Tip Diameter: 9/16" (14 mm)
 Base Diameter: 1" (25 mm)
 Materials: Steel
 Finishes: US3, US4, US5, US10A, US10R, US15A, US15, US26, US26D, ABA
 Fasteners: One (1) #8 x 3/4" PPHWS
 Notes:
 - Bumper made of rubber
 - Flexible spring



RESIDENTIAL



212

Hinge Pin Door Bumper

- Materials: Zinc alloy base
 Finishes: US3, US4, US5, US10A, US10R, US15A, US15, US26, US26D, ABA
 Notes:
 - Non-marking white plastic tip
 - For use where standard door stops are not desirable
 - For use with narrow trim
 - Adjustable from 80 degrees to 120 degrees
 - For use with residential hinges
 - Works with 1/4" (6 mm) hinge pins



1412

Door Guard

- Arm Length: 4 (102 mm)
 Materials: Zinc alloy base
 Finishes: U3, US10A, US15A, US15, US26, US26D, ABA
 Fasteners: Seven (7) #6 x 3/4" FPHWS
 Notes:
 - Provides extra security from inside door
 - Limits door opening when latch is thrown
 - Poly bag (1 each) with screws



1413

Flush Bolt

- Faceplate: 3/4" x 6" (19 mm x 181 mm)
 Strike: 7/8" x 1-3/4" (22 mm x 45 mm)
 Bolt Diameter: 1/2" (13 mm)
 Bolt Throw: 15/16" (24 mm)
 Bolt Backset: 7/16" (11 mm)
 Materials: Brass faceplate with steel components
 Finishes: US3, US4, US5, 10A, 10R, US15A, US15, US26D, ABA, AN
 Fasteners: Four (4) #6 x 3/4" FPHWS
 Notes:
 - Poly bag (1 each) with strikeplate and screws
 - Square corners



1414

Flush Bolt

- Faceplate: 3/4" x 6" (19 mm x 181 mm)
 Strike: 7/8" x 1-3/4" (22 mm x 45 mm)
 Bolt Diameter: 1/2" (12.7 mm)
 Bolt Throw: 15/16" (24 mm)
 Bolt Backset: 7/16" (11 mm)
 Materials: Brass faceplate with steel components
 Finishes: US3, US4, US5, 10A, 10R, US15A, US15, US26, US26D, ABA, AN
 Fasteners: Four (4) #6 x 3/4" FPHWS
 Notes:
 - Poly bag (1 each) with strikeplate and screws
 - Rounded corners





RESIDENTIAL



1415

Strike Plate

- Size: 7/8" x 1-3/4" (22 mm x 45 mm)
 Finishes: US3, US10A, US15A, US15, US26D
 Fasteners: Two (2) #6 x 3/4" FPHWS
 Notes:
 - For use with 1413 and 1414 Flush Bolts
 - Packed (1 each) with Poly bag and screws



1416

Single Route Flush Bolt

- Faceplate: 3/4" x 7-1/8" (19 mm x 181 mm)
 Strike: 21/32" x 1-1/2" (17 mm x 38 mm)
 Bolt Diameter: 5/16" (8 mm)
 Bolt Throw: 7/8" (22 mm)
 Bolt Backset: 3/8" (9.5 mm)
 Materials: Brass faceplate with steel components
 Finishes: US3, US4, US5, US10A, US10R, US15A, US15, US26, US26D, ABA
 Fasteners: Two (2) #8 x 1-1/2" FPHWS and two (2) #6 x 3/4" FPHWS
 Notes:
 - Poly bag (1 each) with strikeplate and screws
 - Rounded corners
 - Single route for quick and simple door prep



1418

Flush Bolt with Extension Rod

- Faceplate: 23/32" x 7-3/8" (18 mm x 187 mm)
 Strike: 5/8" x 1-1/2" (16 mm x 38 mm)
 Bolt Diameter: 5/16" (8 mm)
 Bolt Throw: 3/4" (19 mm)
 Bolt Backset: 3/8" (9.5 mm)
 Extension Rod Length: 16" (406 mm)
 Materials: Brass faceplate with steel components
 Finishes: US3, US4, US5, US10A, US10R, US15A, US15, US26, US26D, ABA
 Fasteners: Two (2) #8 x 1-1/2" FPHWS and two (2) #6 x 3/4" FPHWS
 Notes:
 - Poly bag (1 each) with strikeplate and screws
 - Rounded corners
 - Single route for quick and simple door prep



1419

Flush Bolt with Extension Rod

- Faceplate: 3/4" x 7-1/8" (19 mm x 181 mm)
 Strike: 5/8" x 1-1/2" (16 mm x 38 mm)
 Bolt Diameter: 5/16" (8 mm)
 Bolt throw: 3/4" (19 mm)
 Bolt Backset: 5/16" (8 mm)
 Materials: Brass faceplate with steel components
 Fasteners: Two (2) #8 x 1-1/2" FPHWS and two (2) #6 x 3/4" FPHWS
 Finishes: US3, US4, US10A, US10R, US15, US26, US26D, ABA, AN
 Notes: Single route for quick and simple door prep



RESIDENTIAL



1439 | BL6439

Magnetic Catch - Light Weight

- Catch: 1-1/16" x 2" (27 mm x 51 mm)
 Strike: 7/8" x 1" (22 mm x 25 mm)
 Materials: Tan plastic case
 Fasteners: Two (2) #6 x 1/2" TPHWS and one (1) #4 x 1/2" FPHWS
 Notes:
 - Poly bag (1 each) with screws
 - Double-sided magnet, self-aligning, 6 lb. pull
 - Self aligning magnet insures maximum pull
 - BL6439 is Builder's Pack Poly bag (1 each) with screws



1445

Roller Latch

- Hole Diameter: 13/16" (21 mm)
 Hole Depth: 1-1/8" (29 mm)
 Materials: Zinc alloy base
 Finishes: US3, US4, US5, US10A, US10R, US15A, US15, US26, US26D, ABA
 Fasteners: Two (2) #4 x 3/4" FPHWS
 Notes:
 - Poly bag (1 each) with screws
 - Designed for use on cabinets and lightweight doors
 - Not intended for heavy weight applications



1446

Light Weight Ball Catch

- Faceplate: 1" x 2-1/4" (25 mm x 57 mm)
 Strike: 1-3/8" x 2-1/4" (35 mm x 57 mm)
 Hole Diameter: 1" (25 mm)
 Hole Depth: 1-1/4" (32 mm)
 Materials: Steel housing, brass strike, plated steel ball
 Finishes: US3, US4, US5, US10A, US10R, US15A, US15, US26, US26D
 Fasteners: Four (4) #6 FPHWS
 Notes:
 - Designed for use on cabinets and light weight doors
 - Not intended for heavy weight applications
 - Ball adjusts in and out for various door and frame clearances
 - Poly bag (1 each) with steel screws



1447

Light Weight Ball Catch

- Strike: 1-3/8" x 2-1/4" (35 mm x 57 mm)
 Faceplate: 1" (25 mm) diameter
 Hole Diameter: 15/16" (24 mm)
 Hole Depth: 1-1/4" (32 mm)
 Materials: Zinc housing, brass strike, plated steel ball
 Finishes: US3, US4, US5, US10A, US10R, US15A, US15, US26, US26D
 Fasteners: Two (2) #6 FPHWS
 Notes:
 - Designed for use on cabinets and light weight doors
 - Not intended for heavy weight applications
 - Ball adjusts in and out for various door and frame clearances
 - Poly bag (1 each) with steel screws





RESIDENTIAL



1448 Strike Plate

Size: 1-3/8" x 2-1/4" (35 mm x 57 mm)
 Material: Brass
 Finishes: US3, US4, US5, US10A, US10R, US15A, US15, US26, US26D, ABA
 Fasteners: Two (2) #6 FPHWS
 Notes: For use with 1446 and 1447 ball catches



1449 Drive In Ball Catch

Faceplate: 1" (25 mm) diameter
 Hole Diameter: 15/16" (24 mm)
 Hole Depth: 1-1/4" (32 mm)
 Materials: Zinc housing, plated steel ball
 Finishes: US4
 Packaging: 100 per box
 Notes:

- Ball catch designed for use on cabinets and light weight doors
- Not intended for heavyweight applications
- Ball adjusts in and out for various door and frame clearances



BL6793 Pole Sockets

Outside Diameter: 2-7/16" (62 mm)
 Materials: Steel
 Notes:

- For poles up to 1-3/8" (35 mm) diameter
- Flange design prevents accidental knock out of pole
- Poly bag (2 each) with screws



BL6794 Pole Sockets

Outside Diameter: 2-3/16" (56 mm)
 Materials: Plastic
 Notes:

- For poles up to 1-3/8" (35 mm) diameter
- Poly bag (2 each) with screws



1795 Closet Rod

Pole Diameter: 1" (25 mm)
 Available Lengths: 18" - 30"
 30" - 48"
 48" - 72"
 72" - 96"
 96" - 150"
 Materials: Steel with bright zinc finish
 Finishes: White enamel
 Fasteners: Six (6) #8 x 1" TPH tapping screws
 Notes:

- Quick mount end
- High strength lock seam tubing
- Poly bag (1 each) with screws

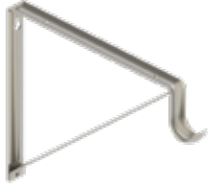

1797

Shelf Bracket with 2-1/2" Drop

Materials: Steel ANSI B04051
 Finishes: White Enamel
 Fasteners: Two (2) #8 x 5/8" PPH tapping screws and two (2) #10 x 1-1/2" PPH tapping screws

- Notes:
- For shelf and rod support
 - Heavy gauge steel construction embossed for added strength
 - Holds 1-3/8" (35 mm) diameter rod
 - Supports 12" (305 mm) shelf
 - Bulk with screws
 - 150 lbs. load rating

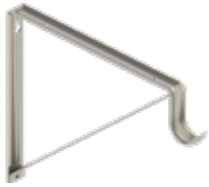

1798

Shelf Bracket with 3" Drop

Materials: Steel ANSI B04051
 Finishes: White Enamel
 Fasteners: Two (2) #8 x 5/8" PPH tapping screws and two (2) #10 x 1-1/2" PPH tapping screws

- Notes:
- For shelf and rod support
 - Heavy gauge steel construction embossed for added strength
 - Holds 1-3/8" (35 mm) diameter rod
 - Supports 12" (305 mm) shelf
 - Bulk with screws
 - 150 lbs. load rating

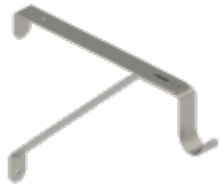

1799

Shelf Bracket - Adjustable

Materials: Steel ANSI B04051
 Finishes: White Enamel
 Fasteners: Two (2) #8 x 3/4" PPH tapping screws and two (2) #10 x 1-1/2" PPH tapping screws

- Notes:
- Adjustable shelf and rod support
 - Heavy gauge steel construction embossed for added strength
 - Holds 1-3/8" (35 mm) diameter rod
 - Supports 12" (305 mm) shelf
 - 3/4" (19 mm) adjustability
 - Bulk with screws



1801

Shelf Bracket

Materials: Steel ANSI B04051
 Finishes: White enamel
 Fasteners: Two (2) #8 x 5/8" PPH tapping screws and two (2) #10 x 1-1/2" PPH tapping screws

- Notes:
- Less rod support
 - Heavy gauge steel construction embossed for added strength
 - Supports 12" (305 mm) shelf
 - Bulk with screws





RESIDENTIAL



6601

Handrail Bracket

Projection:

3-1/4" (82.5 mm)

Base to Center of Rail:

2-3/4" (70 mm)

Materials:

Cast aluminum

Finishes:

US3, US4, US5, US10A, US10R, US15, US15A, US26, US26D, ABA

Fasteners:

Three (3) #8 x 1-1/2" OPHWS and two (2) #8 x 3/4" OPHWS

Notes:

Poly bag (1 each) with wood screws and rail bracket



BL6610

Coat and Hat Hook

Upper Projection:

2-13/16" (71 mm)

Lower Projection:

1-5/16" (33 mm)

Material:

Cast steel

Finishes:

US3, US4, US5, US10A, US15A, US15, US26, US26D, ABA

Fasteners:

Two (2) #6 x 3/4" FPHWS

Notes:

- Poly bag (1 each) with screws
- Builder's pack